

Dry-installed Volute Casing Pump

KWP

Material variant

- GN, GC2, C2 (casing variant 2)
 - GH, H (casing variants 2 and 3)
- Bearing bracket: P03ax to P12sx
Installation types: 3, 4H, 3Z

Installation/Operating Manual



Order number: 9971599122/001900
Order item number: PU-XE-37 A/B
Ident number:

Installation/Operating Manual KWP
Original operating manual

KSB Aktiengesellschaft Pegnitz

All rights reserved. Contents provided herein must neither be distributed, copied, reproduced, processed for any other purpose, nor otherwise transmitted to a third party without KSB's express written consent.

Subject to technical modification without prior notice.

© KSB Aktiengesellschaft Frankenthal 30.12.2009

Contents

	Glossary	5
1	General	6
1.1	Principles	6
1.2	Installation of partly completed machinery	6
1.3	Target group	6
1.4	Other applicable documents	6
1.5	Symbols	6
2	Safety	8
2.1	Key to safety symbols/markings	8
2.2	General	8
2.3	Intended use	8
2.4	Personnel qualification and training	9
2.5	Consequences and risks caused by non-compliance with these operating instructions	10
2.6	Safety awareness	10
2.7	Safety information for the operator/user	10
2.8	Safety information for maintenance, inspection and installation work ...	10
2.9	Unauthorised modes of operation	11
2.10	Explosion protection	11
3	Transport/Temporary Storage/Disposal	13
3.1	Transport	13
3.2	Storage and preservation	14
3.3	Return to supplier	14
3.4	Disposal	15
4	Description of the Pump (Set)	16
4.1	General description	16
4.2	Designation	16
4.3	Name plate	17
4.4	Design	17
4.5	Functional description	20
4.6	Noise characteristics	21
4.7	Scope of supply	21
4.8	Dimensions and weights	21
5	Installation at Site	22
5.1	Safety regulations	22
5.2	Checking the site before installation	22
5.3	Installing the pump set	22
5.4	Piping	24

5.5	Protective equipment	29
5.6	Checking the alignment of coupling/belt drive	29
5.7	Aligning the pump and motor	32
5.8	Electrical connection	35
5.9	Checking the direction of rotation	36
6	Commissioning/Start-up/Shutdown	38
6.1	Commissioning/start-up	38
6.2	Operating limits	43
6.3	Shutdown/storage/preservation	45
6.4	Returning to service after storage	45
7	Servicing/Maintenance	46
7.1	Safety regulations	46
7.2	Servicing/inspection	46
7.3	Drainage/disposal	50
7.4	Dismantling the pump set	50
7.5	Reassembling the pump set	54
7.6	Tightening torques	64
7.7	Spare parts stock	64
8	Trouble-shooting	69
9	Related Documents	71
9.1	General assembly drawing with list of components	71
10	EC Declaration of Conformity	75
11	Certificate of Decontamination	76
	Index	77

Glossary

Back pull-out design

The complete back pull-out unit can be pulled out without having to remove the pump casing from the piping.

Certificate of decontamination

A certificate of decontamination certifies that the pump (set) has been properly drained to eliminate any environmental and health hazards arising from components in contact with the fluid handled.

Discharge line

The line which is connected to the discharge nozzle

Pool of pumps

Pumps which are purchased and stored independently of their later use

Pump

Machine without drive, additional components or accessories

Pump set

Complete pump set consisting of pump, drive, additional components and accessories

Suction lift line/suction head line

The line which is connected to the suction nozzle

1 General

1.1 Principles

This manual is supplied as an integral part of the type series and variants indicated on the front cover. It describes the proper and safe use of this equipment in all phases of operation.

The name plate indicates the type series and size, the main operating data, the order number and the order item number. The order number and order item number clearly identify the pump (set) and serve as identification for all further business processes.

In the event of damage, immediately contact your nearest KSB service centre immediately to maintain the right to claim under warranty.

Noise characteristics (⇒ Section 4.6 Page 21)

1.2 Installation of partly completed machinery

To install partly completed machinery supplied by KSB, please refer to the sub-sections under Servicing/Maintenance. (⇒ Section 7.5.6 Page 61)

1.3 Target group

This manual is aimed at the target group of trained and qualified specialist technical personnel. (⇒ Section 2.4 Page 9)

1.4 Other applicable documents

Table 1: Overview of other applicable documents

Document	Contents
Data sheet	Description of the technical data of the pump (set)
General arrangement drawing/ Outline drawing	Description of mating and installation dimensions for the pump (set)
Drawing of auxiliary connections	Description of auxiliary connections
Hydraulic characteristic curve	Characteristic curves showing head, NPSH required, efficiency and power input
General assembly drawing ¹⁾	Sectional drawing of the pump
Sub-supplier documentation ¹⁾	Operating manuals and other documentation of accessories and integrated machinery components
Spare parts lists ¹⁾	Description of spare parts
Piping layout ¹⁾	Description of auxiliary piping
List of components ¹⁾	Description of all pump components

1.5 Symbols

Table 2: Symbols used in this manual

Symbol	Description
✓	Conditions which need to be fulfilled before proceeding with the step-by-step instructions
▷	Safety instructions
⇒	Result of an action
⇔	Cross-references

¹⁾ If agreed to be included in the scope of supply

Symbol	Description
1. 2.	Step-by-step instructions
	Note Recommendations and important information on how to handle the product







2 Safety



All the information contained in this section refers to hazardous situations.

2.1 Key to safety symbols/markings

Table 3: Definition of safety symbols/markings

Symbol	Description
 DANGER	DANGER This signal word indicates a high-risk hazard which, if not avoided, will result in death or serious injury.
 WARNING	WARNING This signal word indicates a medium-risk hazard which, if not avoided, could result in death or serious injury.
 CAUTION	CAUTION This signal word indicates a hazard which, if not avoided, could result in damage to the machine and its functions.
	Explosion protection This symbol identifies information about avoiding explosions in potentially explosive atmospheres in accordance with EC Directive 94/9/EC (ATEX).
	General hazard In conjunction with one of the signal words this symbol indicates a hazard which will or could result in death or serious injury.
	Electrical hazard In conjunction with one of the signal words this symbol indicates a hazard involving electrical voltage and identifies information about protection against electrical voltage.
	Machine damage In conjunction with the signal word CAUTION this symbol indicates a hazard for the machine and its functions.

2.2 General

This manual contains general installation, operating and maintenance instructions that must be observed to ensure safe pump operation and prevent injury and damage to property.

The safety instructions in all sections of this manual must be complied with.

This manual must be read and completely understood by the responsible specialist personnel/operators prior to installation and commissioning.

The contents of this manual must be available to the specialist personnel at the site at all times.

Instructions attached directly to the pump must always be complied with and be kept in a perfectly legible condition at all times. This applies to, for example:

- Arrow indicating the direction of rotation
- Markings for connections
- Name plate

The operator is responsible for meeting all local regulations which are not taken into account in this manual.

2.3 Intended use

The pump (set) must only be operated within the operating limits described in the other applicable documents.

- Only operate pumps/pump sets which are in perfect technical condition.
- Do not operate partially assembled pumps/pump sets.

- The pump must only be used to handle the fluids specified in the data sheet or product literature of the respective design variant.
- Never operate the pump without the fluid to be handled.
- Observe the minimum flow rates indicated in the data sheet or product literature (to prevent overheating, bearing damage, etc).
- Observe the maximum flow rates indicated in the data sheet or product literature (to prevent overheating, mechanical seal damage, cavitation damage, bearing damage, etc).
- Do not throttle the flow rate on the suction side of the pump (to prevent cavitation damage).
- Consult the manufacturer about any use or mode of operation not described in the data sheet or product literature.
- Only use the different impeller types in combination with the fluids described below.

Table 4: Applications of impeller types

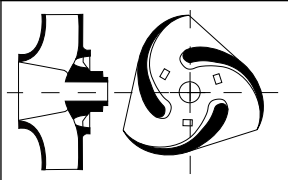
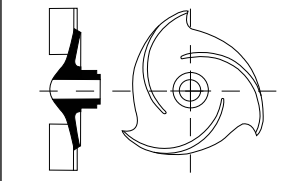
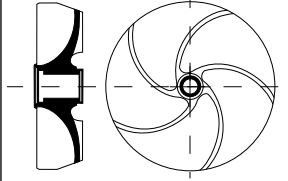
Impeller type		Suitable for the following fluids
	Closed channel impeller (K impeller)	Contaminated, solids-laden fluids, not liable to plait, without or with very little entrapped gas.
	Open multi-vane impeller (O impeller)	Uncontaminated or slightly contaminated fluids as well as fluids liable to form deposits and bunch, with little entrapped gas.
	Open free flow impeller (F impeller)	Fluids containing larger solids and matter liable to plait as well as fluids with entrapped air or gas.

Prevention of foreseeable misuse

- Never open discharge-side shut-off elements further than permitted.
 - The maximum flow rate specified in the data sheet or product literature would be exceeded.
 - Risk of cavitation damage
- Never exceed the permissible operating limits specified in the data sheet or product literature regarding pressure, temperature, etc.
- Observe all safety information and instructions in this manual.

2.4 Personnel qualification and training

All personnel involved must be fully qualified to install, operate, maintain and inspect the machinery this manual refers to.

The responsibilities, competence and supervision of all personnel involved in installation, operation, maintenance and inspection must be clearly defined by the operator.

Deficits in knowledge must be rectified by sufficiently trained specialist personnel training and instructing the personnel who will carry out the respective tasks. If required, the operator can commission the manufacturer/supplier to train the personnel.

Training on the pump (set) must always be supervised by technical specialist personnel.

2.5 Consequences and risks caused by non-compliance with these operating instructions

- Non-compliance with these operating instructions will lead to forfeiture of warranty cover and of any and all rights to claims for damages.
- Non-compliance can, for example, have the following consequences:
 - Hazards to persons due to electrical, thermal, mechanical and chemical effects and explosions
 - Failure of important product functions
 - Failure of prescribed maintenance and servicing practices
 - Hazard to the environment due to leakage of hazardous substances

2.6 Safety awareness

In addition to the safety information contained in this manual and the intended use, the following safety regulations shall be complied with:

- Accident prevention, health and safety regulations
- Explosion protection regulations
- Safety regulations for handling hazardous substances
- Applicable standards and laws

2.7 Safety information for the operator/user

- The operator shall fit contact guards for hot, cold or moving parts and check that the guards function properly.
- Do not remove the contact guard while the pump is running.
- Connect an earth conductor to the metal jacket if the fluid handled is electrostatically charged.
- Provide the personnel with protective equipment and make sure it is used.
- Contain leakages (e.g. at the shaft seal) of hazardous fluids handled (e.g. explosive, toxic, hot) so as to avoid any danger to persons and the environment. Adhere to all relevant laws.
- Eliminate all electrical hazards. (In this respect refer to the applicable national safety regulations and/or regulations issued by the local energy supply companies.)

2.8 Safety information for maintenance, inspection and installation work

- Modifications or alterations of the pump are only permitted with the manufacturer's prior consent.
- Use only original spare parts or parts authorised by the manufacturer. The use of other parts can invalidate any liability of the manufacturer for consequential damage.
- The operator ensures that all maintenance, inspection and installation work is performed by authorised, qualified specialist personnel who are thoroughly familiar with the manual.
- Carry out work on the pump (set) during standstill only.
- The pump casing must have cooled down to ambient temperature.
- Pump pressure must have been released and the pump must have been drained.
- When taking the pump set out of service always adhere to the procedure described in the manual.

- Decontaminate pumps which handle fluids posing a health hazard. (⇒ Section 7.3 Page 50)
- As soon as the work is complete, re-install and/or re-activate any safety-relevant and protective devices. Before returning the product to service, observe all instructions on commissioning. (⇒ Section 6.1 Page 38)

2.9 Unauthorised modes of operation

Never operate the pump (set) outside the limits stated in the data sheet and in this manual.

The warranty relating to the operating reliability and safety of the supplied pump (set) is only valid if the equipment is used in accordance with its intended use.

2.10 Explosion protection



Always observe the instructions on explosion protection given in this section when operating the pump in potentially explosive atmospheres.

Only pumps/pump sets marked as explosion-proof **and** identified as such in the data sheet may be used in potentially explosive atmospheres.

Special conditions apply to the operation of explosion-proof pump sets to EC Directive 94/9/EC (ATEX).

Especially adhere to the sections in this manual marked with the Ex symbol and the following sections (⇒ Section 2.10.1 Page 11) to (⇒ Section 2.10.4 Page 12).

The explosion-proof status of the pump set is only assured if the pump set is used in accordance with its intended use.

Never operate the pump (set) outside the limits stated in the data sheet and on the name plate.

Prevent impermissible modes of operation at all times.

2.10.1 Marking

- Pump** The marking on the pump refers to the pump only.
Example of such marking: II 2 G c TX
Refer to the Temperature limits table for the temperatures permitted for the individual pump variants. (⇒ Section 2.10.2 Page 11)
- Shaft coupling** An EC manufacturer's declaration is required for the shaft coupling; the shaft coupling must be marked accordingly.
- Motor** The motor must be considered separately.

2.10.2 Temperature limits

In normal pump operation, the highest temperatures are to be expected on the surface of the pump casing, at the shaft seal and in the bearing areas.

The surface temperature at the pump casing corresponds to the temperature of the fluid handled. If the pump is heated in addition, the operator of the system is responsible for observing the specified temperature classes and fluid temperature (operating temperature).

The table below lists the temperature classes and the resulting theoretical temperature limits of the fluid handled (a possible temperature rise in the shaft seal area has already been taken into account).

The temperature class specifies the maximum permissible temperature at the surface of the pump set during operation. For the permissible operating temperature of the pump in question refer to the data sheet.

Table 5: Temperature limits

Temperature class as per EN 13463-1	Maximum permissible fluid temperature
T1	Maximum 400 °C ²⁾
T2	280 °C

Temperature class as per EN 13463-1	Maximum permissible fluid temperature
T3	185 °C
T4	120 °C
T5	85 °C
T6	Only after consultation with the manufacturer

Temperature class T5 Based on an ambient temperature of 40 °C and proper maintenance and operation, compliance with temperature class T5 is warranted in the area of the rolling element bearings. If the ambient temperature exceeds 40 °C, contact the manufacturer.

Temperature class T6 A special design is required to comply with the requirements of temperature class T6 in the bearing area.

Misuse, malfunctions or non-compliance with the instructions may result in substantially higher temperatures.

If the pump is to be operated at a higher temperature, the data sheet is missing or if the pump is part of a pool of pumps, contact KSB for the maximum permissible operating temperature.

2.10.3 Monitoring equipment

The pump (set) must only be operated within the limits specified in the data sheet and on the name plate.

If the system operator cannot warrant compliance with these operating limits, appropriate monitoring devices must be used.

Check whether monitoring equipment is required to ensure that the pump set functions properly.

Contact KSB for further information on monitoring equipment.

2.10.4 Operating limits

The minimum flows indicated in section (⇒ Section 6.2.3 Page 44) refer to water and water-like fluids. Longer operating periods with these fluids and at the flow rates indicated will not cause an additional increase in the temperatures on the pump surface. However, if the physical properties of the fluids handled are different from water, it is essential to check if an additional heat build-up may occur and if the minimum flow rate must therefore be increased. The calculation formula in (⇒ Section 6.2.3 Page 44) can be used to check if an additional heat build-up may lead to a hazardous temperature increase at the pump surface.

²⁾ Depending on the material variant

3 Transport/Temporary Storage/Disposal

3.1 Transport

	⚠ DANGER
	<p>The pump (set) could slip out of the suspension arrangement Danger to life if hit by a falling part!</p> <ul style="list-style-type: none"> ▷ Always transport the pump (set) in the specified position. ▷ Never attach the suspension arrangement to the free shaft end or the motor eyebolt. ▷ Refer to the weight given in the general arrangement drawing. ▷ Observe the local accident prevention regulations. ▷ Use suitable, permitted lifting tackle, e.g. self-tightening lifting tongs.

To transport the pump/pump set suspend it from the lifting tackle as follows.

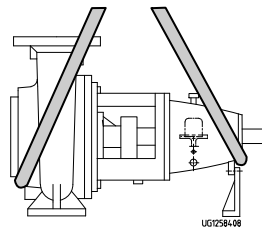

Fig. 1: Transporting the pump

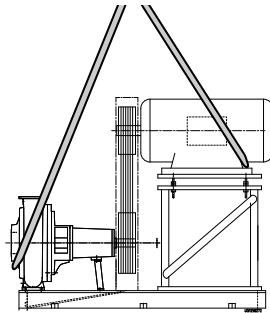

Fig. 2: Transporting a pump set with belt drive (figure 3Z)

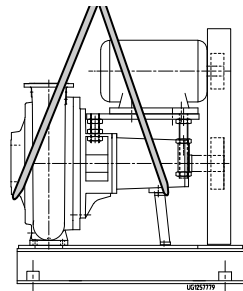

Fig. 3: Transporting a pump set with belt drive (figure 4H)

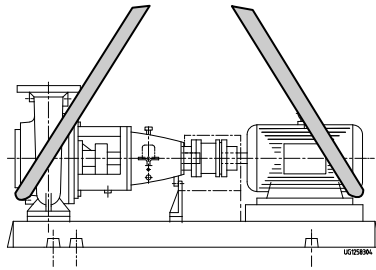

Fig. 4: Transporting a pump set on a baseplate

3.2 Storage and preservation

If commissioning is to take place some time after delivery, we recommend that the following measures be taken for pump (set) storage.

	<p>CAUTION</p> <p>Damage during storage by humidity, dirt, or vermin Corrosion/contamination of the pump (set)!</p> <ul style="list-style-type: none"> ▶ For outdoor storage cover the pump (set) or the packaged pump (set) and accessories with waterproof material.
	<p>CAUTION</p> <p>Wet, contaminated or damaged openings and connections Leakage or damage to the pump set!</p> <ul style="list-style-type: none"> ▶ Only remove caps/covers from the openings of the pump set at the time of installation.

Store the pump (set) in a dry, protected room where the atmospheric humidity is as constant as possible.

Rotate the shaft by hand once a month, e.g. via the motor fan.

If properly stored indoors, the pump set is protected for a maximum of 12 months. New pumps/pump sets are supplied by our factory duly prepared for storage.

For storing a pump (set) which has already been operated, observe the instructions in (⇒ Section 6.3.1 Page 45) .

3.3 Return to supplier

1. Drain the pump as per operating instructions. (⇒ Section 7.3 Page 50)
2. Always flush and clean the pump, particularly if it has been used for handling noxious, explosive, hot or other hazardous fluids.
3. If the fluids handled by the pump leave residues which might lead to corrosion damage when coming into contact with atmospheric humidity, or which might ignite when coming into contact with oxygen, the pump set must also be neutralised, and anhydrous gas must be blown through the pump for drying purposes.
4. Always complete and enclose a certificate of decontamination when returning the pump (set). (⇒ Section 11 Page 76)
Always indicate the safety and decontamination measures taken.

	<p>NOTE</p> <p>If required, a blank certificate of decontamination can be downloaded from the KSB web site at: www.ksb.com/certificate_of_decontamination</p>
--	--

3.4 Disposal

	⚠ WARNING
	Fluids posing a health hazard Hazardous to persons and the environment! <ul style="list-style-type: none">▷ Collect and properly dispose of flushing liquid and any fluid residues.▷ Wear safety clothing and a protective mask, if required.▷ Observe all legal regulations on the disposal of fluids posing a health hazard.

1. Dismantle the pump (set).
Collect greases and other lubricants during dismantling.
2. Separate and sort the pump materials, e.g. by:
 - Metals
 - Plastics
 - Electronic waste
 - Greases and other lubricants
3. Dispose of materials in acc. with local regulations or in another controlled manner.

4 Description of the Pump (Set)

4.1 General description

Pump for handling pre-treated sewage, waste water, all types of slurries (without stringy substances) and pulps up to 5% bone dry.

For use in the chemical and process industries, paper and pulp industries, sugar industry, food and beverages industry, in flue gas desulphurisation, coal upgrading plants and in industrial waste water treatment systems.

Table 6: KWP types of installation

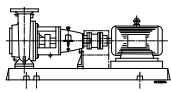
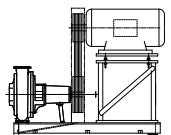
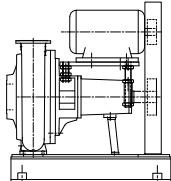
Type of installation ³⁾	Illustration	Description
Figure 3		Pump set with pump directly coupled to the motor
Figure 3Z		Pump set with belt drive. Motor bracket positioned in front of the pump.
Figure 4H		Pump set with belt drive. Motor bracket positioned on top of the pump.

4.2 Designation

Example: KWP K A 100 - 250

Table 7: Key to the designation

Code	Description
KWP	Type series
K	Impeller type, e.g. K = channel impeller
A	Additional code, e.g. A = mechanical seal installed in conical seal chamber
100	Nominal discharge nozzle diameter [mm]
250	Nominal impeller diameter [mm]

³⁾ To ZN 482

4.3 Name plate

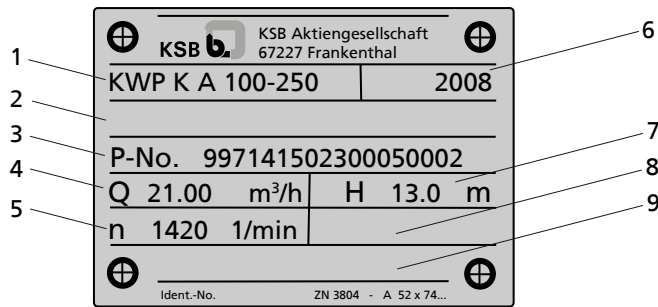

Fig. 5: Name plate KWP

1	Type series, pump size and version	2	Product number or blank
3	Works number for customer order	4	Flow rate
5	Speed	6	Year of construction
7	Head	8	Pump input power or blank
9	Other required details		

4.4 Design

Design

- Volute casing pump
- Back pull-out design
- Horizontal installation
- Single-stage
- Single entry
- Ratings and dimensions in accordance with EN 733

Materials

Code	Description
GN	Standard design <ul style="list-style-type: none"> ▪ Complete pump in JL1040 ▪ Impeller and wear plate in ERN
GC ₂	<ul style="list-style-type: none"> ▪ Like GN ▪ Impeller in Noridur 1.4593
C ₂	Complete hydraulic system in Noridur 1.4593
GH	<ul style="list-style-type: none"> ▪ Casing in JL1040 ▪ Impeller and wear plate in NORIHARD
H	Complete hydraulic system in NORIHARD

Pump casing

- Radially split volute casing
- For combustible fluids: ductile materials containing less than 7.5% magnesium (EN 13463-1)
- Volute casing with integrally cast pump feet
- Pump casing fitted with a wear plate
- Stuffing box housing in one of the following variants:

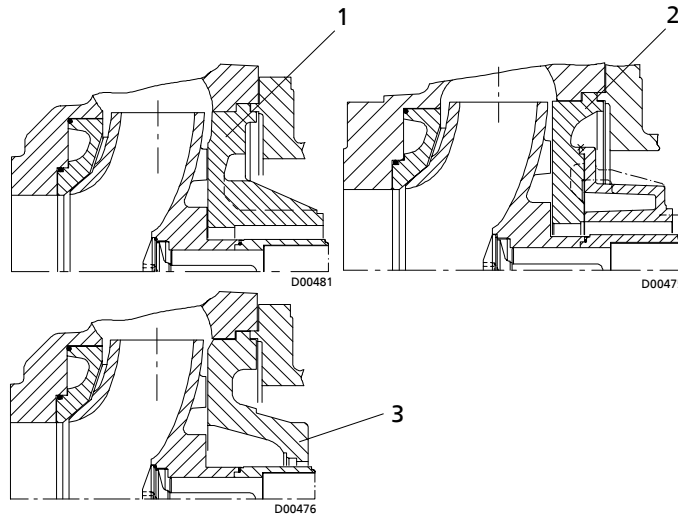

1	Discharge cover with integrally cast stuffing box housing (casing variant 2), material variants: GN, GC ₂ , C ₂	2	Discharge cover with bolted-on stuffing box housing (casing variant 3), material variants: GH, H
3	For mechanical seal: discharge cover with conical seal chamber (A-type cover), material variants: GN, GC ₂ , C ₂ , GH, H		

Impeller type

- Various, application-based impeller types (⇒ Section 2.3 Page 8)
- Back vanes reduce axial thrust.

Bearings

Design specifications

- Oil-lubricated rolling element bearings
- Back pull-out bearing bracket with axially adjustable rotor to adjust the clearance between impeller and wear plate.

Bearings used

Table 8: Standard bearing assembly

Bearing bracket	Rolling element bearings	
	Pump end ⁴⁾	Motor end ⁵⁾
P03ax	NU 409	2 x 7309 BG
P04ax	NU 411	2 x 7311 BG
P05ax	NU 413	2 x 7313 BG
P06x	NU 413	2 x 7313 BG
P08sx	NU 416	2 x 7319 BG
P10ax	NU 324	2 x 7224 BG
P12sx	NU 324	2 x 7224 BG

Refer to the data sheet to find your bearing design.

Shaft seal

- Shaft fitted with a replaceable shaft protecting sleeve in the shaft seal area
- Gland packing

⁴⁾ To DIN 5412

⁵⁾ To DIN 628

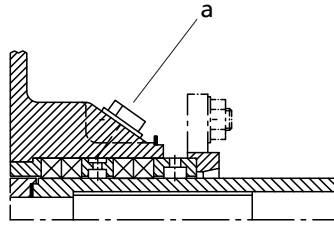

Fig. 6: Gland packing with a) connection for barrier or flushing liquid (connections 10 A.1 and 10 E.1)

- Commercial single and double acting mechanical seals

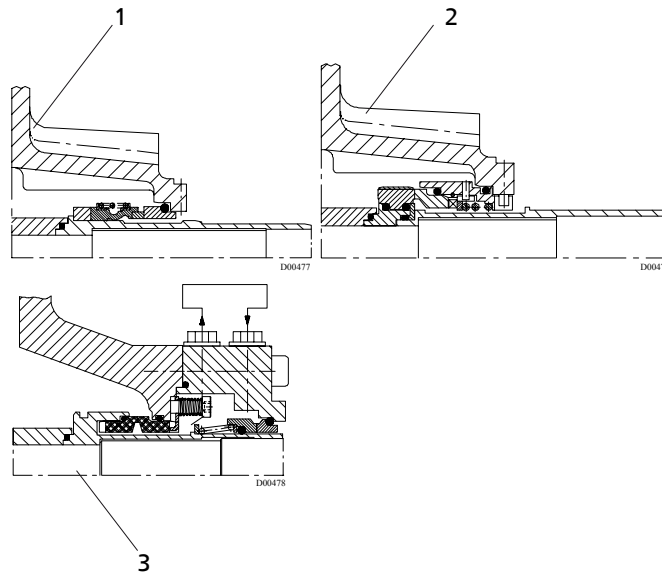

Fig. 7: Mechanical seals in conical seal chamber (A-type)

1	Unbalanced, single-acting mechanical seal	2	Single-acting mechanical seal with stationary spring
3	Mechanical seal in tandem arrangement, with quench		

	⚠ DANGER
	<p>The temperatures at packed glands have risen above the permissible limits Explosion hazard!</p> <ul style="list-style-type: none"> ▷ Always use suitable temperature monitoring for packed glands. ▷ Pack glands properly.

Drive

- Electric motor connected to the pump via a coupling or belt drive.

4.5 Functional description

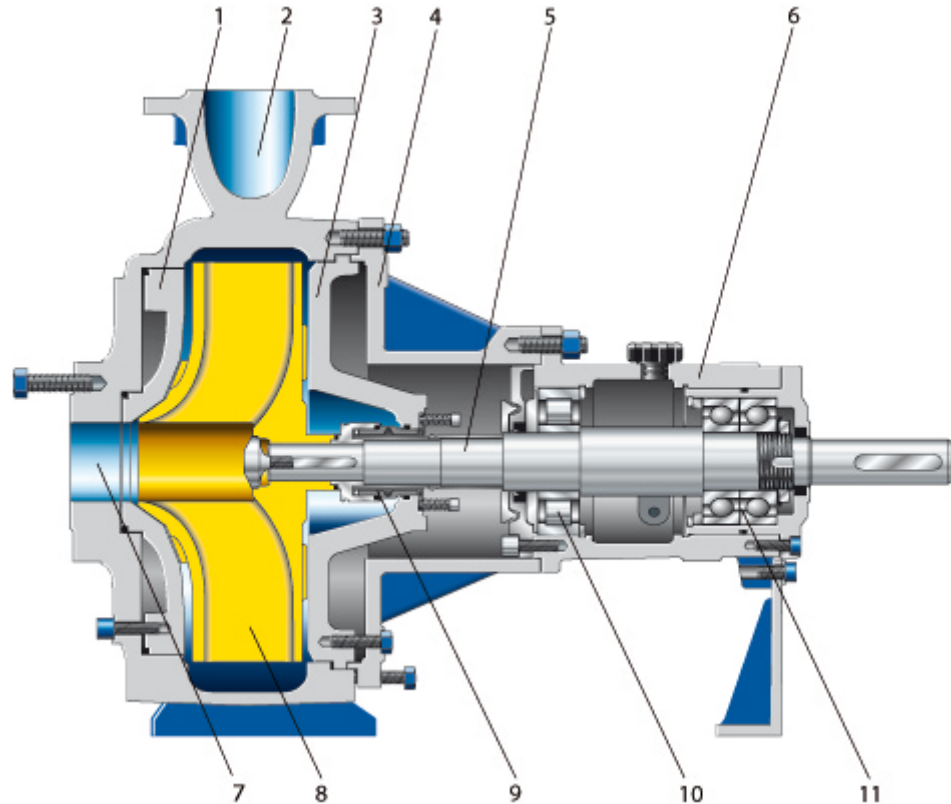

Fig. 8: Sectional drawing

1	Wear plate	2	Casing/discharge nozzle
3	Discharge cover	4	Bearing bracket lantern
5	Shaft	6	Bearing bracket
7	Casing/suction nozzle	8	Impeller
9	Shaft seal	10	Rolling element bearing, pump end
11	Rolling element bearing, motor end		

Design The horizontal, non-self-priming, radially split volute casing pump in back pull-out design is designed with an axial fluid inlet and a radial outlet.

The rotor runs in an axially adjustable bearing and is connected to the motor by a shaft coupling.

Function The steadily rotating impeller of the centrifugal pump transfers mechanical energy to the fluid passing through.

The fluid enters the pump axially via the suction nozzle (7) and is moved outwards by the rotating impeller (8). The flow profile of the pump casing converts the kinetic energy of the fluid into pressure energy. The fluid leaves the pump via the discharge nozzle (2).

The casing is fitted with a replaceable wear plate (1). The diagonal clearance gap prevents frequent deviation of the flow in the clearance gap heading in the direction of the suction nozzle. This ensures a longer service life if solids-laden fluids are handled. The axially adjustable bearing allows an optimum adjustment of the width of the sealing clearance.

The casing is closed by a discharge cover (3). The shaft (5) enters the casing via this discharge cover. A shaft seal (9) provides reliable sealing towards the atmosphere.

The shaft is supported by oil-lubricated rolling element bearings (10 and 11). The bearing bracket (6) is connected to the casing via a lantern (4).

Sealing The pump is sealed by a shaft seal. Variants:

- Mechanical seal (single-acting or in tandem arrangement)
- Gland packing with connection for barrier or flushing liquid in the cylindrical seal chamber

4.6 Noise characteristics

Table 9: Sound pressure level measured at surfaces L_{pA} ^{6) 7)}

Rated power input PN [kW]	Pump set			Pump		
	2900 rpm [dB]	1450 rom [dB]	960/760 rpm [dB]	2900 rpm [dB]	1450 rpm [dB]	960/760 rpm [dB]
1	63	57	55	54	52	51
2	65	59	53	55	53	52
3	67	61	59	57	55	54
4	69	62	61	58	57	55
6	70	64	63	60	58	57
8	71	65	64	61	59	58
11	73	67	66	63	61	60
15	74	68	67	64	62	61
19	75	69	68	65	63	62
22	75	69	68	66	64	63
30	76	71	69	67	65	64
37	77	71	70	68	66	65
45	77	72	71	69	67	66
55	78	73	71	70	68	67
75	-	74	72	-	69	68
90	-	74	73	-	70	69
110	-	75	73	-	71	70
132	-	75	74	-	72	71
160	-	76	74	-	73	72
200	-	76	75	-	75	74
250	-	80	79	-	76	75

4.7 Scope of supply

Depending on the model, the following items are included in the scope of supply:

- Pump
- Drive** ▪ Surface-cooled IEC three-phase current squirrel-cage motor
- Shaft coupling** ▪ Flexible coupling with or without spacer sleeve or belt drive
- Contact guard** ▪ Coupling guard to EN 294 or belt guard
- Baseplate** ▪ Baseplate (to ISO 3661), cast or welded, for pump and motor, in torsion-resistant design
- Special accessories** ▪ As required

4.8 Dimensions and weights

For dimensions and weights please refer to the general arrangement drawing/outline drawing of the pump (set).

⁶⁾ Spatial average to ISO 3744 and EN 12639. Applies to non-cavitating pump operation in the range $Q/Q_{opt} = 0.8 - 1.1$. If noise levels are to be guaranteed: Add +3dB for measurement and manufacturing tolerance.

⁷⁾ For 60 Hz operation: 1750 rpm, + 1dB; 1160 rpm, without allowance.

5 Installation at Site

5.1 Safety regulations

	⚠ DANGER
	<p>Improper installation in potentially explosive atmospheres Explosion hazard! Damage to the pump set!</p> <ul style="list-style-type: none"> ▷ Comply with the applicable local explosion protection regulations. ▷ Observe the information in the data sheet and on the name plates of pump and motor.

5.2 Checking the site before installation

Place of installation

	⚠ WARNING
	<p>Installation on foundations which are unsecured and cannot support the load Personal injury and damage to property!</p> <ul style="list-style-type: none"> ▷ Make sure the foundation concrete is of sufficient strength (min. X0 to DIN 1045). ▷ Only place the pump set on a foundation whose concrete has set firmly. ▷ Only place the pump set on a horizontal and level surface. ▷ Refer to the weights given in the general arrangement drawing.

1. Check the structural requirements.
All structural work required must have been prepared in accordance with the dimensions stated in the outline drawing/general arrangement drawing.

5.3 Installing the pump set

Always install the pump set in horizontal position.

	⚠ DANGER
	<p>Excessive temperatures due to improper installation Explosion hazard!</p> <ul style="list-style-type: none"> ▷ Install the pump in horizontal position to ensure self-venting of the pump.

5.3.1 Installation on the foundation

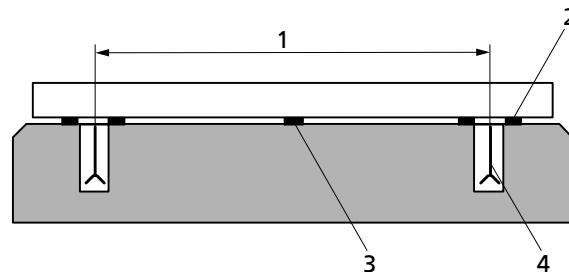

Fig. 9: Fitting the shims

1	Bolt-to-bolt clearance	2	Shim
3	Shim for bolt-to-bolt clearance > 800 mm	4	Foundation bolt

- ✓ The foundation has the required strength and characteristics.

- ✓ The foundation has been prepared in accordance with the dimensions given in the outline drawing/general arrangement drawing.
- 1. Position the pump set on the foundation and align it with the help of a spirit level placed on the shaft and discharge nozzle.
Permissible deviation: 0.2 mm/m.
- 2. Use shims (2) for height compensation, if necessary.
Always fit shims between the baseplate/foundation frame and the foundation itself; always insert them to the left and right of the foundation bolts (4) and in close proximity to these bolts.
For a bolt-to-bolt clearance > 800 mm, fit additional shims (3) halfway between the adjoining holes.
All shims must lie perfectly flush.
- 3. Insert the foundation bolts (4) into the holes provided.
- 4. Use concrete to set the foundation bolts (4) into the foundation.
- 5. Wait until the concrete has set firmly, then align the baseplate.
- 6. Tighten the foundation bolts (4) evenly and firmly.
- 7. Grout the baseplate using low-shrinkage concrete with a standard particle size and a water/cement ratio of ≤ 0.5 .
Produce flowability with the help of a solvent.
Perform secondary treatment of the concrete to DIN 1045.

	NOTE
	For low-noise operation contact KSB to check whether the pump set can be installed on anti-vibration mounts.
	NOTE
	Expansion joints can be fitted between pump and suction/discharge line.

5.3.2 Installation without foundation

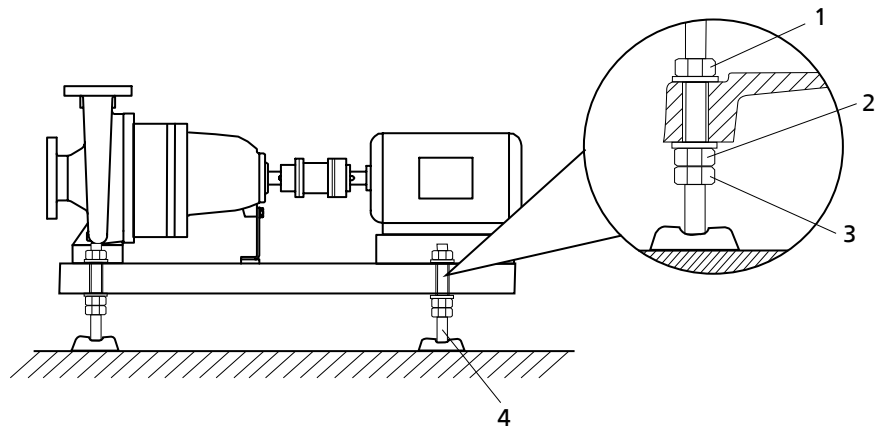

Fig. 10: Adjusting elements





1, 3	Lock nut	2	Adjusting nut
4	Adjusting element		

- ✓ The installation surface has the required strength and characteristics.
- 1. Position the pump set on the adjusting elements (4) and align it with the help of a spirit level (on the shaft/discharge nozzle).
- 2. To adjust any differences in height, loosen the bolts and lock nuts (1, 3) of the adjusting elements (4).
- 3. Turn the adjusting nut (2) until any differences in height have been compensated.

4. Re-tighten the lock nuts (1, 3) at the adjusting elements (4).

5.4 Piping

5.4.1 Connecting the piping

	<p>⚠ DANGER</p> <p>Excessive loads acting on the pump nozzles Danger to life from leakage of hot, toxic, corrosive or flammable fluids!</p> <ul style="list-style-type: none"> ▷ Do not use the pump as an anchorage point for the piping. ▷ Anchor the pipelines in close proximity to the pump and connect them without transmitting any stresses or strains. ▷ Observe the permissible forces and moments at the pump nozzles. ▷ Take appropriate measures to compensate thermal expansion of the piping.
	<p>CAUTION</p> <p>Incorrect earthing during welding work at the piping Destruction of rolling element bearings (pitting effect)!</p> <ul style="list-style-type: none"> ▷ Never earth the electric welding equipment on the pump or baseplate. ▷ Prevent current flowing through the rolling element bearings.
	<p>NOTE</p> <p>It is recommended to install check and shut-off elements in the system, depending on the type of plant. However, these elements must not obstruct proper drainage or hinder disassembly of the pump.</p>
<ul style="list-style-type: none"> ✓ The suction lift line/suction head line has been laid with a rising/downward slope towards the pump. ✓ The nominal diameters of the pipelines are at least equal to the nominal diameters of the pump nozzles. ✓ To prevent excessive pressure losses, adapters to larger diameters have a diffuser angle of approx. 8°. ✓ The pipelines have been anchored in close proximity to the pump and connected without transmitting any stresses or strains. <ol style="list-style-type: none"> 1. Thoroughly clean, flush and blow through all vessels, pipelines and connections (especially of new installations). 2. Before installing the pump in the piping, remove the flange covers on the suction and discharge nozzles of the pump. 	
	<p>CAUTION</p> <p>Welding beads, scale and other impurities in the piping Damage to the pump!</p> <ul style="list-style-type: none"> ▷ Free the piping from any impurities. ▷ If necessary, install a filter. ▷ Observe the instructions in (⇒ Section 7.2.2.2 Page 48).

3. If required, install a filter in the piping (see illustration: Filter in the piping)

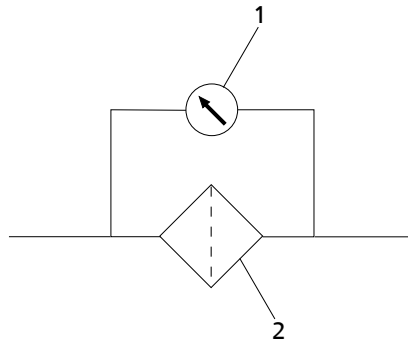

Fig. 11: Filter in the piping

1	Differential pressure gauge	2	Filter
---	-----------------------------	---	--------

	NOTE
<p>Use a filter with laid-in wire mesh (mesh width 0.5 mm, wire diameter 0.25 mm) of corrosion-resistant material. Use a filter three times the diameter of the piping. Conical filters have proved suitable.</p>	

4. Connect the pump nozzles to the piping.

	CAUTION
<p>Aggressive flushing and pickling agents Damage to the pump!</p> <p>▸ Match the cleaning operation mode and duration for flushing and pickling service to the casing and seal materials used.</p>	

5.4.2 Permissible forces and moments at the pump nozzles

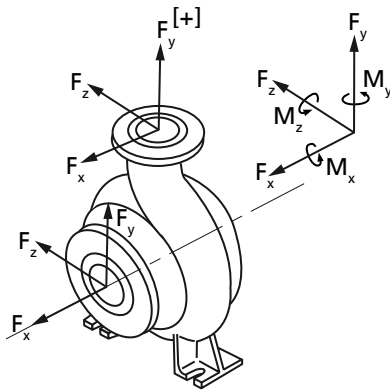

The resulting permissible forces have been determined according to the following formulas:

$$F_{res D} \leq \sqrt{F_x^2 + F_z^2}$$

$$F_{res S} \leq \sqrt{F_y^2 + F_z^2}$$

Forces and moments at the pump nozzles

The data on forces and moments apply to static pipelines only. If the limits are exceeded, they must be checked and verified.

If a computerised strength analysis is required, please contact KSB!

The values are only applicable if the pump is installed on a completely grouted baseplate and bolted to a rigid and level foundation.

The forces and moments were determined on the basis of API 610 (6th edition), table 2, values doubled.

Correction coefficients depending on material and temperature (see diagram below).

Material variant C₂: Temperature-dependent correction coefficients

For material variant C₂ at temperatures >20 °C reduce the values indicated in (=> table 10, page 27) as per the following diagram:

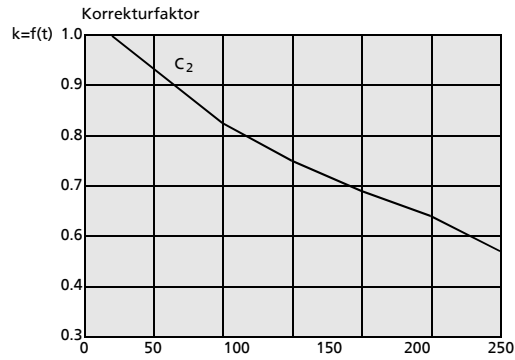

Fig. 12: Correction coefficient for material variant C₂:

Calculation of forces and moments if t > 20 °C

Reduction formula: k (t) x forces/moments in the table

Example:

- Material = C₂
- t = 100°C
- k = 0.825 (multiplication of data in table by 0.82)

Also see

- Material variant C₂ (Noridur) [⇒ 27]
- Material variant C₂ (Noridur) [⇒ 27]

5.4.2.1 Material variant C2 (Noridur)

Table 10: Material variant C₂ (Noridur): Permissible forces and moments at the pump nozzles⁸⁾

Pump size	Nozzle diameter		Forces									Moments					
			Suction nozzle				Discharge nozzle					Suction nozzle			Discharge nozzle		
	SS	DS	F _x [N]	F _y [N]	F _z [N]	F _{res} [N]	F _x [N]	F _{yTens+} [N]	F _{yPress} [N]	F _z [N]	F _{res} [N]	M _x [Nm]	M _y [Nm]	M _z [Nm]	M _x [Nm]	M _y [Nm]	M _z [Nm]
40-250	65	40	3145	2065	2515	3235	1527	990	1975	1255	1975	2065	1525	1080	990	810	540
40-315	80	40	3860	2515	3055	3950						2605	1975	1345			
50-200	65	50	3145	2065	2515	3235	1527	990	1975	1255	1975	2065	1525	1080	1255	990	630
50-400	80	50	3860	2515	3055	3950	1975	1255	2425	1615	2515	2605	1975	1345			
65-200	80	65	3860	2515	3055	3950	2515	1615	3145	2065	3235	2605	1975	1345	2065	1525	1080
65-315	80	65															
65-400	80	65															
80-250	100	80	4850	3145	3860	4940	3055	1975	3860	2515	3950	3595	2695	1795	2605	1975	1345
80-315	100	80															
80-400	100	80															
80-500	125	80	6645	4310	5300	6825						4940	3770	2515			
100-250	125	100	6645	4310	5300	6825	3860	2425	4850	3145	5030	4940	3770	2515	3595	2695	1795
100-315	125	100															
100-400	125	100															
125-315	150	125	8445	5570	6735	8710	5300	3325	6645	4310	6825	6200	4760	3145	4940	3770	2515
125-400	150	125															
125-500	150	125															
150-315	150	150	8445	5570	6735	8710	6735	4220	8445	5570	8710	6200	4760	3145	6200	4760	3145
150-400	150	150															
200-320	200	200	13205	8445	10240	13295	10240	6380	13205	8445	13295	9520	6915	4760	9520	6915	4760
200-400	200	200															
200-500	200	200															
250-315	250	250	17965	12035	14370	18770	14370	8980	17965	12035	18770	13470	10240	6555	13470	10240	6555
250-400	250	250															
250-500	250	250															
250-630	250	250															
300-400	300	300	21555	14370	17965	22995	17965	11045	21555	14370	22995	16435	12395	8085	16435	12395	8085
300-500	300	300															
350-400	350	350	23980	15630	19220	24790	19220	12035	23980	15630	24790	17155	12845	8445	17155	12845	8445
350-500	350	350															
350-630	350	350															

⁸⁾ For temperatures >20 °C: Adjust the values using the temperature correction coefficients (see previous page).

5.4.2.2 Material variants GN, GH, GC2, H (cast iron, Norihard)

Table 11: Material variants GN, GH, GC₂, H (cast iron, Norihard): Permissible forces and moments at the pump nozzles⁹⁾

Pump size	Nozzle diameter		Forces									Moments					
			Suction nozzle				Discharge nozzle					Suction nozzle			Discharge nozzle		
	SS	DS	F _x [N]	F _y [N]	F _z [N]	F _{res} [N]	F _x [N]	F _{yTens} [N]	F _{yPress} [N]	F _z [N]	F _{res} [N]	M _x [Nm]	M _y [Nm]	M _z [Nm]	M _x [Nm]	M _y [Nm]	M _z [Nm]
40-250	65	40	1750	1150	1400	1800	850	550	1100	700	1100	1150	850	600	550	450	300
40-315	80	40	2150	1400	1700	2200						1450	1100	750			
50-200	65	50	1750	1150	1400	1800	850	550	1100	700	1100	1150	850	600	700	550	350
50-400	80	50	2150	1400	1700	2200	1100	700	1350	900	1400	1450	1100	750			
65-200	80	65	2150	1400	1700	2200	1400	900	1750	1150	1800	1450	1100	750	1150	850	600
65-315	80	65															
65-400	80	65															
80-250	100	80	2700	1750	2150	2750	1700	1100	2150	1400	2200	2000	1500	1000	1450	1100	750
80-315	100	80															
80-400	100	80															
80-500	125	80	3700	2400	2950	3800						2750	2100	1400			
100-250	125	100	3700	2400	2950	3800	2150	1350	2700	1750	2800	2750	2100	1400	2000	1500	1000
100-315	125	100															
100-400	125	100															
125-315	150	125	4700	3100	3750	4750	2950	1850	3700	2400	3800	3450	2650	1750	2750	2100	1400
125-400	150	125															
125-500	150	125															
150-315	150	150	4700	3100	3750	4850	3750	2350	4700	3100	4850	3450	2650	1750	3450	2650	1750
150-400	150	150															
200-320	200	200	7350	4700	5700	7400	5700	3550	7350	4700	7400	5300	3850	2650	5300	3850	2650
200-400	200	200															
200-500	200	200															
250-315	250	250	10000	6700	8000	10450	8000	5000	10000	6700	6700	7500	5700	3650	7500	5700	3650
250-400	250	250															
250-500	250	250															
250-630	250	250															
300-400	300	300	12000	8000	10000	12800	10000	6150	12000	8000	12800	9150	6900	4500	9150	6900	4500
300-500	300	300															
350-400	350	350	13350	8700	10700	13800	10700	6700	13350	8700	13800	9550	7150	4700	9550	7150	4700
350-500	350	350															
350-630	350	350															

⁹⁾ Application: up to 200 degrees C (without temperature-based reduction); for other sizes: consult KSB.

5.4.3 Auxiliary connections

	CAUTION
	<p>Failure to use or incorrect use of auxiliary connections (e.g. barrier fluid, flushing liquid, etc.) Malfunction of the pump!</p> <ul style="list-style-type: none"> ▶ Refer to the general arrangement drawing, the piping layout and pump markings (if any) for the dimensions and locations of auxiliary connections. ▶ Use the auxiliary connections provided.

5.5 Protective equipment

	⚠ DANGER
	<p>Insufficient venting / Unsuitable belt guard material Risk of explosion!</p> <ul style="list-style-type: none"> ▶ Make sure the space between the casing cover/discharge cover and the bearing cover is sufficiently vented. ▶ Never close or cover the perforation of the contact guards at the bearing bracket (e.g. by insulation). ▶ Choose a belt guard material that is non-sparking in the event of mechanical contact (see DIN EN 13463-1).

	⚠ WARNING
	<p>Unprotected rotating pulleys Risk of injury by rotating pulleys!</p> <ul style="list-style-type: none"> ▶ Always operate the pump set with a belt guard. If the customer specifically requests not to include a belt guard in KSB's delivery, then the operator must supply one! ▶ Observe all relevant regulations for selecting a belt guard.

	⚠ WARNING
	<p>The volute casing and casing/discharge cover take on the same temperature as the fluid handled Risk of burning!</p> <ul style="list-style-type: none"> ▶ Insulate the volute casing. ▶ Fit protective equipment.

	CAUTION
	<p>Heat build-up in the bearing bracket Damage to the bearing!</p> <ul style="list-style-type: none"> ▶ Never insulate the bearing bracket, bearing bracket lantern and casing cover.

5.6 Checking the alignment of coupling/belt drive

After the pump set has been installed (⇒ Section 5.3 Page 22) and connected to the piping (⇒ Section 5.4 Page 24), check the coupling alignment or belt drive, depending on the type of installation.

5.6.1 Checking the coupling alignment

	<p>⚠ DANGER</p>
	<p>Inadmissible temperatures at the coupling or bearings due to misalignment of the coupling Explosion hazard!</p> <p>▷ Make sure that the coupling is correctly aligned at all times.</p>
	<p>CAUTION</p>
	<p>Misalignment of pump and motor shafts Damage to pump, motor and coupling!</p> <p>▷ Always check the coupling after the pump has been installed and connected to the piping.</p> <p>▷ Also check the coupling of pump sets supplied with pump and motor mounted on the same baseplate.</p>

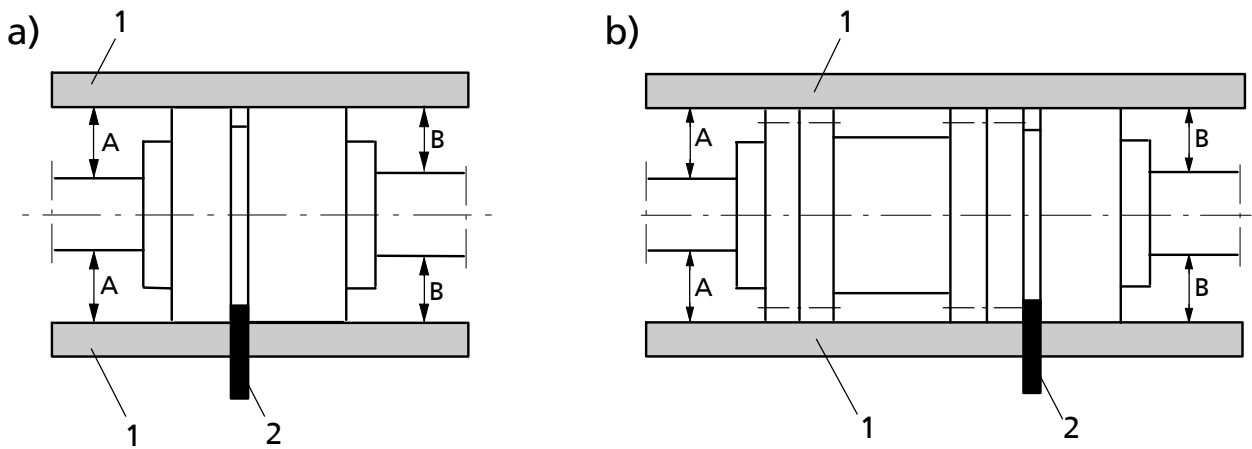



Fig. 13: a) Checking the coupling alignment and b) Aligning a spacer-type coupling

1	Straight-edge	2	Wedge gauge
---	---------------	---	-------------

- ✓ The coupling guard and step guard, if any, have been removed.
- 1. Loosen the support foot and re-tighten it without transmitting any stresses and strains.
- 2. Place the straight-edge axially on both coupling halves.
- 3. Leave the straight-edge in this position and turn the coupling by hand.
The coupling is correctly aligned if the distances A) and B) to the respective shafts are the same at all points around the circumference.
The radial and axial deviation of both coupling halves must not exceed 0.1 mm during standstill as well as at operating temperature and under inlet pressure.
- 4. Check the distance between the two coupling halves around the circumference.
The coupling is correctly aligned if the distance between the two coupling halves is the same at all points around the circumference.
The radial and axial deviation of both coupling halves must not exceed 0.1 mm during standstill as well as at operating temperature and under inlet pressure.

5.6.2 Checking the belt drive

Safety notes

	<p>⚠ DANGER</p> <p>Electrostatic charging Explosion hazard! Damage to the pump set!</p> <ul style="list-style-type: none"> ▷ Connect PE conductor to the earthing terminal provided. ▷ On belt-driven pump sets use belts made of conductive material.
	<p>CAUTION</p> <p>Poorly checked and aligned motor connection Increased wear, insufficient power transmission, loud running noises!</p> <ul style="list-style-type: none"> ▷ Always use clean pulleys without any signs of wear. ▷ Align the shaft end of pump/motor flush with the pulleys. ▷ For multiple V-belt drives: use V-belts of the same length. ▷ Tension the V-belts properly.

5.6.2.1 Checking the pulleys and V-belts

- ✓ Comply with the instructions set forth in section (⇒ Section 5.6.2 Page 31).
1. Remove the belt guard.
 2. Check that pulleys and V-belts fulfil the following conditions:
 - Pulleys are free from burrs, rust and dirt.
 - V-belts are not worn.
 - For multiple V-belt drives: All V-belts have the same length.
 3. Replace any pulleys effected by burrs or rust.
 4. Clean any dirty pulleys.
 5. If replacing V-belts always replace the entire set of V-belts.

5.6.2.2 Checking the alignment of pump and motor shaft

- ✓ The notes and steps stated in (⇒ Section 5.6.2 Page 31) to (⇒ Section 5.6.2.1 Page 31) have been observed/carried out.
1. Measure the distance between the shaft stubs in two points with a straight-edge. The shafts are correctly aligned, if the distances in both measurement points are equal (the axes are parallel).
 2. If the distances differ, align the motor bracket by turning threaded rods 904.23/904.24 until the distance in both measurement points is identical.

5.6.2.3 Checking the alignment of the pulleys

- ✓ The notes and steps stated in (⇒ Section 5.6.2.2 Page 31) to (⇒ Section 5.6.2.2 Page 31) have been observed/carried out.
 - ✓ Required tools: wedge gauge, straight-edge
1. Place the straight-edge (1) vertically on both pulleys.
 2. Leave the straight-edge (1) in this position and turn the measurement point further by hand.
 3. Adjust the alignment, if required. (⇒ Section 7.5.9 Page 63)
 4. Re-install the belt guard.

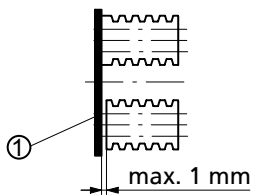

Fig. 14: Checking the pulleys

5.6.2.4 Checking the belt tension

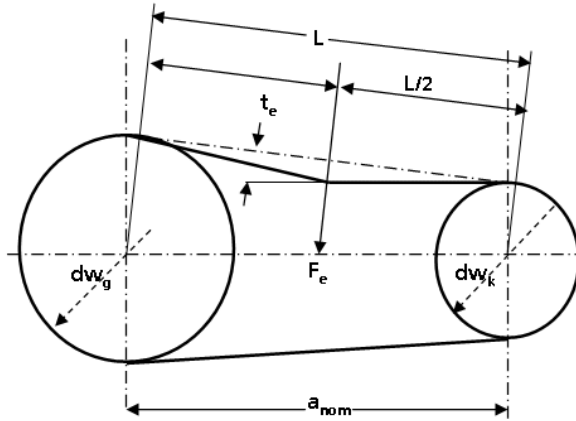

Fig. 15: Tension check for V-belts

✓ The notes and steps stated in (⇒ Section 5.6.2 Page 31) to (⇒ Section 5.6.2.3 Page 31) have been observed/carried out.

1. Check the tension of the V-belt with a belt tension measuring tool (measuring tool not included in the scope of supply).
2. If the tension is incorrect: Tension the V-belts. (⇒ Section 5.7.3 Page 34).

Tension forces for V-belts

Table 12: Form for tension forces

Variable	Value	Unit
Test force [F_e]	N
Deflection distance of individual belts [t_e]	mm
The set of V-belts consists of: <ul style="list-style-type: none"> ▪ Quantity: ▪ Dimension: ▪ Effective length [LW]	mm
Diameter of large pulley [d_{w_g}]	mm
Diameter of small pulley [d_{w_k}]	mm
Speed [n]	rpm
Distance between pulleys [$a_{nom.}$]	mm

5.7 Aligning the pump and motor

5.7.1 Motors with levelling screw

Any differences in shaft centre height between the pump and motor are adjusted with levelling screws.

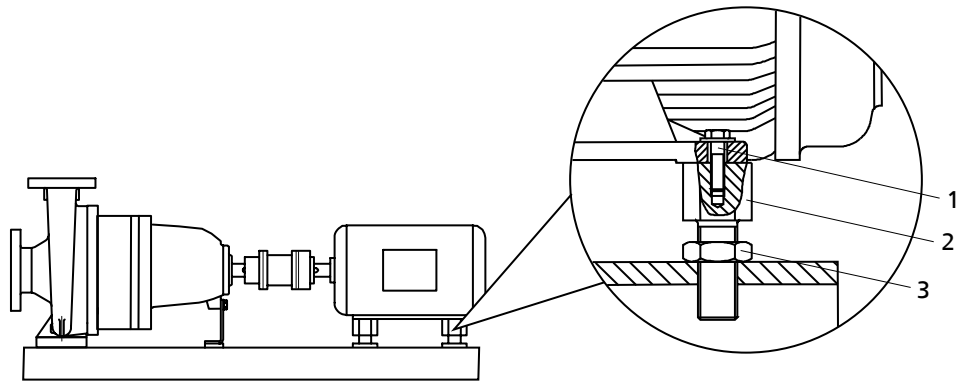

Fig. 16: Motor with levelling screw

1	Hexagon head bolt	2	Levelling screw
3	Lock nut		

- ✓ Misalignment of the coupling (⇒ Section 5.6.1 Page 30).
 - ✓ Coupling guard and step guard, if any, have been removed.
1. Loosen the hexagon head bolts (1) at the motor and the lock nuts (3) at the baseplate.
 2. Turn the levelling screws (2) by hand or by means of an open-jawed wrench until the coupling alignment is correct.
 3. Re-tighten the hexagon head bolts (1) at the motor and the lock nuts (3) at the baseplate.
 4. Check that the coupling and shaft can easily be rotated by hand.

	<p>⚠ WARNING</p> <p>Unprotected rotating coupling Risk of injury by rotating shafts!</p> <ul style="list-style-type: none"> ▷ Always operate the pump set with a coupling guard. If the customer specifically requests not to include a coupling guard in KSB's delivery, then the operator must supply one! ▷ Observe all relevant regulations for selecting a coupling guard.
	<p>⚠ DANGER</p> <p>Risk of ignition by frictional sparks Explosion hazard!</p> <ul style="list-style-type: none"> ▷ Choose a coupling guard material that is non-sparking in the event of mechanical contact (see DIN EN 13463-1).

5. Reinstall the coupling guard and step guard, if any.
6. Check the distance between coupling and coupling guard. The coupling guard must not touch the coupling.

5.7.2 Motors without levelling screw

Any differences in shaft centre height between the pump and the motor are compensated by means of shims.

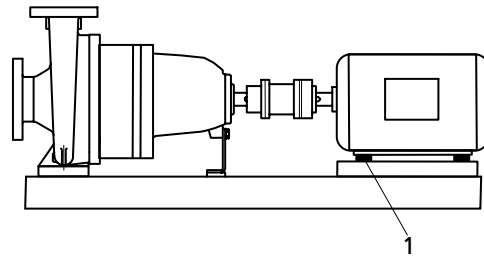

Fig. 17: Pump set with shim

1	Shim
---	------

- ✓ Misalignment of the coupling (⇒ Section 5.6.1 Page 30).
 - ✓ The coupling guard and step guard, if any, have been removed.
1. Unscrew the hexagon head bolts at the motor.
 2. Insert shims (1) underneath the motor feet until the difference in shaft centre height has been compensated.
 3. Re-tighten the hexagon head bolts.
 4. Check that the coupling and shaft can easily be rotated by hand.
Check that coupling/shaft can easily be rotated by hand.

	⚠ WARNING
	<p>Unprotected rotating coupling Risk of injury by rotating shafts!</p> <ul style="list-style-type: none"> ▷ Always operate the pump set with a coupling guard. If the customer specifically requests not to include a coupling guard in KSB's delivery, then the operator must supply one! ▷ Observe all relevant regulations for selecting a coupling guard.

	⚠ DANGER
	<p>Risk of ignition by frictional sparks Explosion hazard!</p> <ul style="list-style-type: none"> ▷ Choose a coupling guard material that is non-sparking in the event of mechanical contact (see DIN EN 13463-1).

5. Reinstall the coupling guard and step guard, if any.
6. Check the distance between coupling and coupling guard.
The coupling guard must not touch the coupling.

5.7.3 Pump sets with belt drive

	CAUTION
	<p>Incorrect tension Insufficient power transmission! Increased wear of the V-belt!</p> <ul style="list-style-type: none"> ▷ Always ensure correct tensioning of the V-belt.

- ✓ The belt guard has been removed.
 - ✓ The tension of the V-belts is too low or too high (⇒ Section 5.6.2.4 Page 32)..
1. Move motor bracket 81-54.01 up or down by turning threaded rods 904.23/904.24 until the V-belt is tensioned correctly.
Tension forces (⇒ Section 5.6.2.4 Page 32)
 2. Check the tension of the V-belt with a belt tension measuring tool (measuring tool not included in the scope of supply).
 3. Check the tension again between ½ hour and 1 hour after initial operation.

- If the tension is too low or too high, re-adjust the motor bracket and check the tension again.

	⚠ DANGER
	<p>Risk of ignition by frictional sparks Risk of explosion!</p> <ul style="list-style-type: none"> ▶ Choose a belt guard material that is non-sparking in the event of mechanical contact (see DIN EN 13463-1).

	⚠ WARNING
	<p>Unprotected rotating pulleys Risk of injury by rotating pulleys!</p> <ul style="list-style-type: none"> ▶ Always operate the pump set with a belt guard. If the customer specifically requests not to include a belt guard in KSB's delivery, then the operator must supply one! ▶ Observe all relevant regulations for selecting a belt guard.

- Re-install the belt guard.
- Check the distance between V-belt and belt guard.
The belt guard must not touch the V-belt.

5.8 Electrical connection

	⚠ DANGER
	<p>Incorrect electrical installation Explosion hazard!</p> <ul style="list-style-type: none"> ▶ For electrical installation, also observe the requirements of IEC 60079-14. ▶ Always connect explosion-proof motors via a motor protection switch.

	⚠ DANGER
	<p>Work on the pump set by unqualified personnel Danger of death from electric shock!</p> <ul style="list-style-type: none"> ▶ Always have the electrical connections installed by a trained electrician. ▶ Observe regulations IEC 30364 (DIN VDE 0100) and, for explosion-proof pump sets, IEC 60079 (DIN VDE 0165).

	⚠ WARNING
	<p>Incorrect connection to the mains Damage to the mains network, short circuit!</p> <ul style="list-style-type: none"> ▶ Observe the technical specifications of the local energy supply companies.

- Check the available mains voltage against the data on the motor name plate.
- Select an appropriate start-up method.

	NOTE
	<p>It is recommended to fit a motor protection device.</p>

5.8.1 Setting the time relay

	CAUTION
	<p>Switchover between star and delta on three-phase motors with star-delta starting takes too long. Damage to the pump (set)!</p> <ul style="list-style-type: none"> ▷ Keep switch-over intervals between star and delta as short as possible (see table: Time relay settings for star-delta starting).

Table 13: Time relay settings for star-delta starting:

Motor rating	Y time to be set
≤ 30 kW	< 3 s
> 30 kW	< 5 s

5.8.2 Connecting the motor

	NOTE
	<p>In compliance with DIN VDE 0530 - Part 8, three-phase motors are always wired for clockwise rotation (looking at the motor shaft stub). The pump's direction of rotation is indicated by an arrow on the pump.</p>

1. Change the motor's direction of rotation to match that of the pump.
2. Observe the manufacturer's product literature supplied with the motor.

5.8.3 Earthing

	⚠ DANGER
	<p>Electrostatic charging Explosion hazard! Damage to the pump set!</p> <ul style="list-style-type: none"> ▷ Connect PE conductor to the earthing terminal provided. ▷ On belt-driven pump sets use belts made of conductive material.

5.9 Checking the direction of rotation

	⚠ DANGER
	<p>Temperature increase resulting from contact between rotating and stationary components Explosion hazard! Damage to the pump set!</p> <ul style="list-style-type: none"> ▷ Never check the direction of rotation by starting up the unfilled pump set. ▷ Separate the pump from the motor to check the direction of rotation.

	⚠ WARNING
	<p>Hands or objects inside the pump casing Risk of injuries, damage to the pump!</p> <ul style="list-style-type: none"> ▷ Never insert your hands or any other objects into the pump. ▷ Check that the inside of the pump is free from any foreign objects.

	CAUTION
	<p>Incorrect direction of rotation with non-reversible mechanical seal Damage to the mechanical seal and leakage!</p> <ul style="list-style-type: none"> ▷ Separate the pump from the motor to check the direction of rotation.

CAUTION	
	<p>Motor and pump running in the wrong direction of rotation Damage to the pump!</p> <ul style="list-style-type: none">▷ Refer to the arrow indicating the direction of rotation on the pump.▷ Check the direction of rotation. If required, interchange any two phases to correct the direction of rotation.

The correct direction of rotation of motor and pump is clockwise (seen from the motor end).

1. Start the pump set and stop it again immediately to determine the motor's direction of rotation.
2. Check the direction of rotation.
The motor's direction of rotation must match the arrow indicating the direction of rotation on the pump.
3. If the pump runs in the wrong direction of rotation, check the electrical connection of the motor and the control system, if necessary.

6 Commissioning/Start-up/Shutdown

6.1 Commissioning/start-up

6.1.1 Prerequisites for commissioning/start-up

Before starting up the pump set make sure that the following requirements are met:

- The pump set has been properly connected to the electric power supply and is equipped with all protection devices.
- The pump has been primed with the fluid to be handled. (⇒ Section 6.1.4 Page 39)
- The direction of rotation has been checked. (⇒ Section 5.9 Page 36)
- All auxiliary connections required are connected and operational.
- The lubricants have been checked.
- After prolonged shutdown of the pump (set), the activities described in (⇒ Section 6.4 Page 45) have been carried out.

6.1.2 Filling in lubricants

Oil-lubricated bearings



Fill the bearing bracket with lubricating oil.

Oil quality see (⇒ Section 7.2.3.1.2 Page 49)

Oil quantity see (⇒ Section 7.2.3.1.3 Page 49)

Filling the constant level oiler with lubricating oil (for oil-lubricated bearings only)

- ✓ The constant level oiler is screwed into the upper tapping hole of the bearing bracket.

	NOTE
	<p>If no constant level oiler is provided on the bearing bracket, the oil level can be read in the middle of the oil level sight glass arranged at the side of the bearing bracket (optional).</p> <p>Figure 4H: If access to the vent plug is difficult or impossible, the oil can be filled in through the connection elbow of the constant level oiler.</p>
	CAUTION
	<p>Insufficient lubricating oil in the reservoir of the constant-level oiler Damage to the bearings!</p> <ul style="list-style-type: none"> ▷ Regularly check the oil level. ▷ Always fill the oil reservoir completely. ▷ Keep the oil reservoir properly filled at all times.

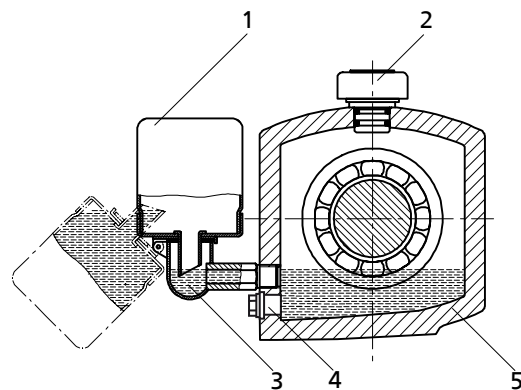

Fig. 18: Bearing bracket with constant level oiler

1	Constant level oiler	2	Vent plug
3	Connection elbow of the constant level oiler	4	Screwed plug
5	Bearing bracket		

1. Pull out the vent plug (2).
2. Hinge down the reservoir of the constant level oiler (1) from the bearing bracket (5) and hold in this position.
3. Fill in oil through the hole for the vent plug until the oil reaches the connection elbow of the constant level oiler (3).
4. Completely fill the reservoir of the constant level oiler (1).
5. Snap the constant level oiler (1) back into its operating position.
6. Fit the vent plug (2) again.
7. After approximately 5 minutes, check the oil level in the glass reservoir of the constant level oiler (1).
The oil reservoir must be properly filled at all times to provide an optimum oil level. Repeat steps 1 - 6, if necessary.
8. To check the function of the constant level oiler (1), slowly drain some oil via the screwed plug (4) until air bubbles can be seen in the oil reservoir.

	NOTE
	An excessively high oil level can lead to a temperature rise and to leakage of the fluid handled or oil.

6.1.3 Shaft seal

Shaft seals are fitted prior to delivery.
Observe the instructions on dismantling (⇒ Section 7.4.6 Page 53) or reassembly (⇒ Section 7.5.4 Page 56) .

Reservoir of non-pressurised external fluid
Double-acting mechanical seal
External liquid feed

If applicable, fill the reservoir of non-pressurised external fluid in accordance with the general arrangement drawing.
Prior to starting up the pump, apply barrier pressure or supply flushing/quench liquid as specified in the general arrangement drawing.
Apply the quantities and pressures specified in the data sheet and the general arrangement drawing.

6.1.4 Filling and venting the pump

	⚠ DANGER
	<p>An explosive atmosphere forms inside the pump Explosion hazard!</p> <ul style="list-style-type: none"> ▷ The pump internals in contact with the fluid to be handled, including the seal chamber and auxiliary systems must be filled with the fluid to be handled at all times. ▷ Provide sufficient inlet pressure. ▷ Provide an appropriate monitoring system.

	⚠ DANGER
	<p>Shaft seal failure caused by dry running Hot or toxic fluid could escape! Damage to the pump!</p> <ul style="list-style-type: none"> ▷ Before starting up the pump set, vent the pump and suction line and fill both with the fluid to be handled.

1. Vent the pump and suction line and fill both with the fluid to be handled.

2. Fully open the shut-off element in the suction line.
3. Fully open all auxiliary connections (barrier fluid, flushing liquid, etc).

6.1.5 Water cooling

	CAUTION
	<p>Deposit forming, aggressive cooling water Damage to the pump!</p> <ul style="list-style-type: none"> ▷ Observe the cooling water quality.

Observe the following quality data of the cooling water:

- Not deposit forming
- Not aggressive
- Free from suspended solids
- Hardness on average 5 °dH (~1mmol/l)
- pH > 8
- Conditioned and neutral with regard to mechanical corrosion
- Inlet temperature $t_{e=}$ 10 to 30 °C
Outlet temperature $t_{A=}$ maximum 45 °C

6.1.6 Final check

1. Remove the coupling/belt guard and step guard, if any.
2. Check the alignment of coupling/belt drive (⇒ Section 5.6 Page 29); re-align, if required. (⇒ Section 5.7 Page 32)
3. Check the function of coupling/shaft/belt drive.
Check that coupling/shaft can easily be rotated by hand.
4. Reinstall the coupling/belt guard and step guard, if any.
5. Check the distance between coupling and coupling guard or V-belt and belt guard.
The coupling guard must not touch the coupling; the belt guard must not touch the pulleys.

6.1.7 Start-up

	⚠ DANGER
	<p>The permissible pressure and temperature limits will be exceeded if the pump is operated with the suction and discharge lines closed. Explosion hazard! Leakage of hot or toxic fluids!</p> <ul style="list-style-type: none"> ▷ Never operate the pump with the shut-off elements in the suction line and/or discharge line closed. ▷ Only start up the pump set with the discharge side gate valve slightly or fully open.

	⚠ DANGER
	<p>Excessive temperatures due to dry running or excessive gas content in the fluid handled Explosion hazard! Damage to the pump set!</p> <ul style="list-style-type: none"> ▷ Never operate the pump set without liquid fill. ▷ Prime the pump as specified. (⇒ Section 6.1.4 Page 39) ▷ Always operate the pump within the permissible operating range.

	CAUTION
	<p>Abnormal noises, vibrations, temperatures or leakage Damage to the pump!</p> <ul style="list-style-type: none"> ▷ Switch off the pump (set) immediately. ▷ Eliminate the causes before returning the pump set to service.

- ✓ The system piping has been cleaned.
- ✓ Pump, suction line and inlet tank, if any, have been vented and filled with the fluid handled.
- ✓ The filling and venting lines have been closed.

	CAUTION
	<p>Start-up against open discharge line Overloading of the motor!</p> <ul style="list-style-type: none"> ▷ Use a soft starter. ▷ Use speed control. ▷ Make sure the power reserve of the motor is sufficient.

1. Fully open the shut-off element in the suction head/suction lift line.
2. Close or slightly open the shut-off element in the discharge line.
3. Switch on the motor.
4. Immediately after the pump has reached full rotational speed, slowly open the shut-off valve in the discharge line and adjust it to comply with the duty point.

	⚠ DANGER
	<p>Seal leakage at operating temperature Hot or toxic fluid could escape!</p> <ul style="list-style-type: none"> ▷ After the operating temperature has been reached and/or in the event of leakage, switch off the pump set and re-tighten the bolts between lantern and casing. ▷ Check the coupling alignment. Re-align the coupling if required.

5. After the operating temperature has been reached and/or in the event of leakage, switch off the pump set and re-tighten the bolts between lantern and casing.
6. Once the operating temperature has been reached, check the coupling/belt drive alignment and re-align, if required.

6.1.8 Checking the shaft seal

Mechanical seal The mechanical seal only leaks slightly or invisibly (as vapour) during operation. Mechanical seals are maintenance-free.

Gland packing The gland packing must leak slightly during operation.

Make sure the throughflow of any sealing and flushing liquid connections provided is checked continuously.

	⚠ DANGER
	<p>The temperatures at packed glands have risen above the permissible limits Risk of explosion!</p> <ul style="list-style-type: none"> ▷ Pack glands properly. ▷ If the gland packing has been retightened to the limit, the gland has to be completely repacked. ▷ Always use suitable temperature monitoring for packed glands.

Pure graphite packing If pure graphite packings are used, there must always be some leakage.

Table 14: Leakage rate of pure graphite packing (rings)

Quantity	Leakage rate
Minimum	10 cm ³ /min
Maximum	20 cm ³ /min

Adjusting the leakage

Prior to commissioning

1. Only lightly tighten the nuts of the gland follower by hand.
 2. Use a feeler gauge to verify that the gland follower is mounted centred and at a right angle to the shaft.
- ⇒ The gland must leak after the pump has been primed.

After five minutes of operation

The leakage can be reduced.

1. Tighten the nuts of the gland follower by 1/6 turn.
2. Monitor the leakage for another five minutes.

Excessive leakage:

Repeat steps 1 and 2 until the minimum value has been reached.

Not enough leakage:

Slightly loosen the nuts at the gland follower.

No leakage:

Switch off the pump set immediately!

Loosen the gland follower and repeat start-up.

Checking the leakage

After the leakage has been adjusted, monitor the leakage for about two hours at maximum fluid temperature.

Check that enough leakage occurs at the gland at minimum fluid pressure.

6.1.9 Shutdown

- ✓ The shut-off element in the suction line is and remains open.
 - ✓ On pump sets with double-acting mechanical seal, properly vent the mechanical seal chamber and apply the required pressure specified in the general arrangement drawing (also during standstill).
 - ✓ Also ensure quench liquid supply during pump standstill.
1. Close the shut-off element in the discharge line.
 2. Switch off the motor and make sure the pump set runs down smoothly to a standstill.

	<p>NOTE</p> <p>If the discharge line is equipped with a non-return or check valve, the shut-off valve may remain open.</p>
	<p>NOTE</p> <p>If shut-off is not possible, the pump will run in reverse direction. The reverse runaway speed must be lower than the rated speed.</p>
	<p>CAUTION</p> <p>Danger of frost/freezing during standstill of the pump Damage to the pump!</p> <ul style="list-style-type: none"> ▷ Drain the pump and any cooling/heating chambers and protect them against freezing.

For prolonged shutdown periods:

1. Close the shut-off element in the suction line.
2. Close the auxiliary connections.
If the fluid to be pumped is fed in under vacuum, also supply the shaft seal with

barrier liquid during standstill.

Only turn off the cooling liquid supply after the pump has cooled down.

3. Drain the pump. (⇒ Section 7.3 Page 50)

6.2 Operating limits

	⚠ DANGER
	<p>Non-compliance with application limits for pressure, temperature and speed Explosion hazard! Hot or toxic fluid may escape!</p> <ul style="list-style-type: none"> ▸ Comply with the operating data indicated in the data sheet. ▸ Avoid prolonged operation against a closed shut-off valve. ▸ Never operate the pump at temperatures exceeding those specified in the data sheet or on the name plate unless the written consent of the manufacturer has been obtained.

6.2.1 Ambient temperature

	CAUTION
	<p>Operation outside the permissible ambient temperature Damage to the pump (set)!</p> <ul style="list-style-type: none"> ▸ Observe the specified limits for permissible ambient temperatures.

Observe the following parameters and values during operation:

Table 15: Permissible ambient temperatures

Permissible ambient temperature	Value
Maximum	40 °C
Minimum	See data sheet.

6.2.2 Frequency of starts

	⚠ DANGER
	<p>Excessive surface temperature of the motor Explosion hazard! Damage to the motor!</p> <ul style="list-style-type: none"> ▸ In case of explosion-proof motors, observe the switching frequency specified in the manufacturer's product literature.

The frequency of starts is usually determined by the maximum temperature increase of the motor. This largely depends on the power reserves of the motor in steady-state operation and on the starting conditions (d.o.l., star-delta, moments of inertia, etc). If the start-ups are evenly spaced over the period indicated, the following limits can be used for orientation for start-up with the discharge-side gate valve slightly open:

Table 16: Frequency of starts

Motor rating [kW]	Maximum No. of start-ups [Start-ups/hour]
up to 12	15
up to 100	10
more than 100	5

	CAUTION
	<p>Re-start while motor is still running down Damage to the pump (set)!</p> <p>▷ Do not re-start the pump set before the pump rotor has come to a standstill.</p>

6.2.3 Flow rate

Unless specified otherwise in the characteristic curves or in the data sheets, the following applies:

- Short-time operation: $Q_{min}^{10)} = 0.1 \times Q_{opt}^{11)}$
- Continuous operation: $Q_{min}^{10)} = 0.3 \times Q_{opt}^{11)}$
- 2-pole operation: $Q_{max}^{12)} = 1,1 \times Q_{opt}^{11)}$
- 4-pole operation: $Q_{max}^{12)} = 1.25 \times Q_{opt}^{11)}$

The data refer to water and water-like fluids. Longer operating periods with these fluids and at the flow rates indicated will not cause an additional increase in the temperatures on the pump surface. However, if the physical properties of the fluids handled are different from water, the calculation formula below must be used to check if an additional heat build-up may lead to a dangerous temperature increase at the pump surface. If necessary, the minimum flow must be increased.

$$T_o = T_f + \Delta \vartheta$$

$$\Delta \vartheta = \frac{g * H}{c * \eta} * (1 - \eta)$$

Table 17: Key

Symbol	Description	Unit
c	Specific heat capacity	J/kg K
g	Gravitational constant	m/s ²
H	Pump head	m
T _f	Temperature of the fluid handled	°C
T _o	Temperature at the casing surface	°C
η	Pump efficiency at duty point	-
Δϑ	Temperature difference	°C

6.2.4 Density of the fluid handled

The power input of the pump increases in proportion to the density of the fluid handled.

	CAUTION
	<p>Excessive density of the fluid handled Motor overload!</p> <p>▷ Observe the information on fluid density indicated in the data sheet.</p> <p>▷ Make sure the power reserve of the motor is sufficient.</p>

6.2.5 Abrasive fluids

Do not exceed the maximum permissible solids content specified in the data sheet. When the pump handles fluids containing abrasive substances, increased wear of the hydraulic system and the shaft seal are to be expected. In this case, reduce the intervals commonly recommended for servicing and maintenance.

10) Minimum permissible flow rate
 11) Best efficiency point
 12) Maximum permissible flow rate

6.3 Shutdown/storage/preservation

6.3.1 Measures to be taken for shutdown

The pump (set) remains installed

- ✓ Sufficient fluid is supplied for the operation check run of the pump.
- 1. Start up the pump (set) regularly once a month or once every three months for approximately five minutes during prolonged shutdown periods. This will prevent the formation of deposits within the pump and the pump intake area.

The pump (set) is removed from the pipe and stored

- ✓ The pump has been properly drained (⇒ Section 7.3 Page 50) and the safety instructions for dismantling the pump have been observed. (⇒ Section 7.4.1 Page 50)
- 1. Spray-coat the inside wall of the pump casing, and in particular the impeller clearance areas, with a preservative.
- 2. Spray the preservative through the suction and discharge nozzles. It is advisable to then close the pump nozzles (e.g. with plastic caps or similar).
- 3. Oil or grease all blank parts and surfaces of the pump (with silicone-free oil and grease, food-approved if required) to protect them against corrosion. Observe any additional information provided. (⇒ Section 3.2 Page 14)

If the pump set is to be stored temporarily, only preserve the wetted components made of low alloy materials. Commercially available preservatives can be used for this purpose. Observe the manufacturer's instructions for application/removal.

Observe any additional instructions and information provided. (⇒ Section 3 Page 13)

6.3.2 Putting new pumps/pump sets into storage



If commissioning is to take place some time after delivery, we recommend that the following measures be taken for pump (set) storage:

- Store the pump (set) in a dry and protected location.
- If properly stored indoors, the pump set is protected for a maximum of 12 months. New pumps are supplied by our factory duly prepared for storage.
- Rotate the shaft by hand once a month.

6.4 Returning to service after storage

For returning the pump to service observe the sections on commissioning/start-up (⇒ Section 6.1 Page 38) and the operating limits (⇒ Section 6.2 Page 43) .

In addition, carry out all servicing/maintenance operations before returning the pump (set) to service. (⇒ Section 7 Page 46)

	<p>⚠ WARNING</p> <p>Failure to re-install or re-activate protective devices Risk of personal injury from moving parts or escaping fluid!</p> <ul style="list-style-type: none"> ▷ As soon as the work is complete, re-install and/or re-activate any safety-relevant and protective devices.
	<p>NOTE</p> <p>If the pump has been out of service for more than one year, replace all elastomer seals.</p>

7 Servicing/Maintenance

7.1 Safety regulations

	⚠ DANGER
	<p>Improperly serviced pump set Explosion hazard! Damage to the pump set!</p> <ul style="list-style-type: none"> ▷ Service the pump set regularly. ▷ Prepare a maintenance schedule with special emphasis on lubricants, shaft seal and coupling.

The operator ensures that all maintenance, inspection and installation work is performed by authorised, qualified specialist personnel who are thoroughly familiar with the manual.

	⚠ WARNING
	<p>Pump set started up inadvertently Risk of injury by moving parts!</p> <ul style="list-style-type: none"> ▷ Always make sure the electrical connections are disconnected before carrying out work on the pump set. ▷ Make sure that the pump set cannot be switched on accidentally.

	⚠ WARNING
	<p>Fluids posing a health hazard or hot fluids Risk of personal injury!</p> <ul style="list-style-type: none"> ▷ Observe all relevant laws. ▷ When draining the fluid take appropriate measures to protect persons and the environment. ▷ Decontaminate pumps handling fluids posing a health hazard.

A regular maintenance schedule will help avoid expensive repairs and contribute to trouble-free, reliable operation of the pump (set) with a minimum of maintenance expenditure and work.





	NOTE
	<p>All maintenance, service and installation work can be carried out by KSB Service. Find your contact in the attached "Addresses" booklet or on the Internet at www.ksb.com/contact".</p>

Never use force when dismantling and reassembling a pump set.

7.2 Servicing/inspection

7.2.1 Operation monitoring

	⚠ DANGER
	<p>An explosive atmosphere forms inside the pump Explosion hazard!</p> <ul style="list-style-type: none"> ▷ The pump internals in contact with the fluid to be handled, including the seal chamber and auxiliary systems must be filled with the fluid to be handled at all times. ▷ Provide sufficient inlet pressure. ▷ Provide an appropriate monitoring system.

	<p>⚠ DANGER</p> <p>Incorrectly serviced shaft seal Explosion hazard! Fire hazard! Leakage of hot, toxic fluids! Damage to the pump set!</p> <p>▷ Regularly service the shaft seal.</p>
	<p>⚠ DANGER</p> <p>Excessive temperatures as a result of bearings running hot or defective bearing seals Explosion hazard! Fire hazard! Damage to the pump set!</p> <p>▷ Regularly check the rolling element bearings for running noises.</p>
	<p>CAUTION</p> <p>Increased wear due to dry running Damage to the pump set!</p> <p>▷ Never operate the pump set without liquid fill. ▷ Never close the shut-off element in the suction line and/or supply line during pump operation.</p>
	<p>CAUTION</p> <p>Excessive fluid temperature Damage to the pump!</p> <p>▷ Prolonged operation against a closed shut-off element is not permitted (heating up of the fluid). ▷ Observe the temperature limits in the data sheet and in the section on Operating limits. (⇒ Section 6.2 Page 43)</p>

While the pump is in operation, observe and check the following:

- The pump must run quietly and free from vibrations at all times.
- In case of oil lubrication, ensure the oil level is correct. (⇒ Section 6.1.2 Page 38)
- Check the shaft seal. (⇒ Section 6.1.8 Page 41)
- Check the static seals for leakages.
- Check the rolling element bearings for running noises.
Vibrations, noise and an increase in current input occurring during unchanged operating conditions indicate wear.
- Monitor the correct functioning of any auxiliary connections.
- Cooling system
Take the pump out of service at least once year to thoroughly clean the cooling system.
- Monitor the stand-by pump.
To make sure that the stand-by pumps are ready for operation, start them up once a week.
- Monitor the bearing temperature.
The bearing temperature must not exceed 90 °C (measured on the outside of the bearing bracket).

	CAUTION
	<p>Operation outside the permissible bearing temperature Damage to the pump!</p> <ul style="list-style-type: none"> ▶ The bearing temperature of the pump (set) must never exceed 90 °C (measured on the outside of the motor housing).

7.2.2 Inspection work

7.2.2.1 Checking the coupling

Check the flexible elements of the coupling. Replace these parts in due time if there is any sign of wear.

7.2.2.2 Cleaning filters

	CAUTION
	<p>Insufficient inlet pressure due to clogged filter in the suction line Damage to the pump!</p> <ul style="list-style-type: none"> ▶ Monitor contamination of filter with suitable means (e.g. differential pressure gauge). ▶ Clean filter in appropriate intervals.

7.2.2.3 Checking the bearing seals

	⚠ DANGER
	<p>Excessive temperatures caused by mechanical contact Risk of explosion! Damage to the pump set!</p> <ul style="list-style-type: none"> ▶ Check correct seating of axial sealing rings mounted on the shaft. Only gentle contact shall be established between the sealing lip and the shaft.

7.2.3 Lubrication and lubricant change of rolling element bearings

	⚠ DANGER
	<p>Excessive temperatures as a result of bearings running hot or defective bearing seals Explosion hazard! Fire hazard! Damage to the pump set!</p> <ul style="list-style-type: none"> ▶ Regularly check the condition of the lubricant.

7.2.3.1 Oil lubrication

The rolling element bearings are lubricated with mineral oil.

7.2.3.1.1 Intervals

Table 18: Oil change intervals

Oil change	Interval	
	Bearing bracket up to P04ax	Bearing bracket up to P05ax
Initial oil change	After 300 operating hours	After 300 operating hours
Further oil changes	After 6000 operating hours ¹³⁾	After 8000 operating hours ¹³⁾

If the oil is contaminated, change it more frequently.

7.2.3.1.2 Oil quality

- Lubricants**
- SAE 20W/20HD
 - or
 - CLP 68 to DIN 51 517

Characteristics

Table 19: Lubricant characteristics

Speed [rpm]	Temperature [°C] ¹⁴⁾	Kinematic viscosity at 50 °C		Density at 15 °C [kg/m ³]	Flash point [°C]	Solidification point (pour point) [°C]	Lubricating oil to DIN 51517
		[cSt]	[~ E]				
up to 3500	up to 80	36 ± 4	4.8	895	150	-9	C36
up to 3500	80 to 120	68 ± 6	9.0	900	175	-9	C68
up to 3500	-15 to +60	25 ± 4	3.5	895	150	-25	C-T 25 ¹⁵⁾

7.2.3.1.3 Oil quantity

Table 20: Standard bearing assembly

Bearing bracket	Rolling element bearings		Oil quantity [l]
	Pump end ¹⁶⁾	Motor end ¹⁷⁾	
P03ax	NU 409	2 x 7309 BG	0.5
P04ax	NU 411	2 x 7311 BG	0.6
P05ax	NU 413	2 x 7313 BG	1.8
P06x	NU 413	2 x 7313 BG	1.8
P08sx	NU 416	2 x 7319 BG	4.5
P10ax	NU 324	2 x 7224 BG	4
P12sx	NU 324	2 x 7224 BG	4

7.2.3.1.4 Changing the oil

	<p>⚠ WARNING</p>
	<p>Lubricants posing a health hazard Risk to persons and the environment!</p> <ul style="list-style-type: none"> ▷ When draining the lubricant take appropriate measures to protect persons and the environment. ▷ Observe all legal regulations on the disposal of liquids posing a health hazard.

13) At least once a year.

14) Lowest ambient temperature and highest bearing temperature

15) When ordering, special agreements on the pour point might be required.

16) To DIN 5412

17) To DIN 628

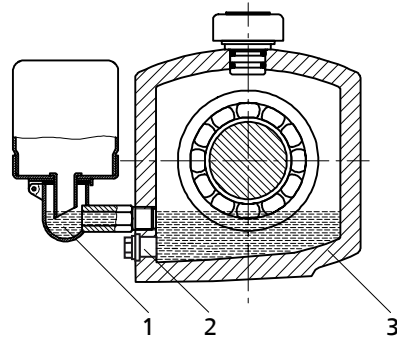

Fig. 19: Bearing bracket with constant-level oiler

1	Constant-level oiler	2	Screwed plug
3	Bearing bracket		

- ✓ A suitable container for the used oil is on hand.
- 1. Place the container underneath the screwed plug.
- 2. Undo the screwed plug (2) at the bearing bracket (3) and drain the oil.
- 3. Once the bearing bracket (3) has been drained, re-insert and re-tighten the screwed plug (2).
- 4. Re-fill with oil.

7.3 Drainage/disposal

	<p>⚠ WARNING</p>
	<p>Fluids posing a health hazard Hazardous to persons and the environment!</p> <ul style="list-style-type: none"> ▷ Collect and properly dispose of flushing liquid and any fluid residues. ▷ Wear safety clothing and a protective mask, if required. ▷ Observe all legal regulations on the disposal of fluids posing a health hazard.

If the fluids handled by the pump (set) leave residues which might lead to corrosion when coming into contact with atmospheric humidity, or which might ignite when coming into contact with oxygen, the pump (set) must be flushed through, neutralised, and blown through with anhydrous gas for drying purposes.

Use connection 6B to drain the fluid handled (see auxiliary connections).

7.4 Dismantling the pump set

7.4.1 General notes/Safety regulations



	<p>⚠ WARNING</p>
	<p>Unqualified personnel performing work on the pump (set) Risk of personal injury!</p> <ul style="list-style-type: none"> ▷ Always have repair and maintenance work performed by specially trained, qualified personnel.

	<p>⚠ WARNING</p>
	<p>Hot surface Risk of personal injury!</p> <ul style="list-style-type: none"> ▷ Allow the pump set to cool down to ambient temperature.

Observe the general safety instructions and information. (⇒ Section 7.1 Page 46)

For any work on the motor, observe the instructions of the relevant motor manufacturer.

For dismantling and reassembly observe the exploded view and the general assembly drawing.

	NOTE
	All maintenance, service and installation work can be carried out by KSB Service. Find your contact in the attached "Addresses" booklet or on the Internet at www.ksb.com/contact .
	⚠ DANGER
	Insufficient preparation of work on the pump (set) Risk of personal injury! <ul style="list-style-type: none"> ▷ Properly shut down the pump set. ▷ Close the shut-off elements in the suction and discharge line. ▷ Drain the pump and release the pump pressure. (⇒ Section 7.3 Page 50) ▷ Close any auxiliary connections. ▷ Allow the pump set to cool down to ambient temperature.
	NOTE
	After a prolonged period of operation the individual parts may be hard to pull off the shaft. If this is the case, use a brand name penetrating agent and/or - if possible - an appropriate pull-off device.

7.4.2 Preparing the pump set

1. Disconnect the power supply (e.g. at the motor).
2. Disconnect and remove any auxiliary pipework.
3. Remove the coupling/belt guard.
4. Remove the coupling spacer, if any.
5. Drain the oil fill of oil-lubricated models. (⇒ Section 7.2.3.1.4 Page 49).

7.4.3 Dismantling the motor

	⚠ WARNING
	Motor tipping over Risk of squashing hands and feet! <ul style="list-style-type: none"> ▷ Suspend or support the motor to prevent it from tipping over.

Model with coupling

	NOTE
	For pump sets with spacer-type couplings, the back pull-out unit can be removed while the motor remains screwed to the baseplate.

✓ The notes and steps stated in (⇒ Section 7.4.1 Page 50) to (⇒ Section 7.4.2 Page 51) have been observed/carried out.

1. Disconnect the motor from the power supply.
2. Undo the screwed connection of the coupling.
3. Unbolt the motor from the baseplate.
4. Shift the motor to separate it from the pump.

Models with belt drive

1. Disconnect the motor from the power supply.

2. Lower motor bracket 81-54.01 by turning threaded rods 904.23/904.24 and nuts 920.63/920.64 until the V-belts slacken.
3. Remove the V-belts.
4. Undo hexagon bolts 901.62 of the motor at the motor bracket and remove discs 550.62.
5. Lift the motor off the motor bracket.
6. Undo hexagon nuts 920.23/920.24 at the pump or motor stand (Figure 3Z).
7. Remove the motor bracket from the pump or baseplate (Figure 3Z) and put it down.
8. Undo bushing 540.02 at pump-end to remove pulley 882.01.
9. Take pulley 882.01 off shaft 210.

7.4.4 Removing the back pull-out unit

- ✓ The notes and steps stated in (⇒ Section 7.4.1 Page 50) to (⇒ Section 7.4.3 Page 51) have been observed/carried out.
- ✓ On pump sets with belt drive or pump sets with coupling without spacer, the motor has been removed.

	⚠ WARNING
	Back pull-out unit tipping over Risk of squashing hands and feet! ▶ Suspend or support the back pull-out unit at the pump end.

1. Loop a rope tightly around bearing bracket lantern 344.
2. Unbolt support foot 183 from the baseplate and remove it.
3. Undo hexagon nuts 920.01 at the volute casing.
4. Pull the back pull-out unit out of volute casing 101.

	NOTE
	You can use forcing screws 901.31 for the disassembly. Clean the forcing screws before using them.

5. Place the back pull-out unit on a clean and level surface.
6. Remove and dispose of joint ring 411.10.

7.4.5 Dismantling the impeller

Bearing brackets P03ax, P04ax, P05ax, P06x

- ✓ The notes and steps stated in (⇒ Section 7.4.1 Page 50) to (⇒ Section 7.4.4 Page 52) have been observed/carried out.
 - ✓ The back pull-out unit is kept in a clean and level assembly area.
1. Undo impeller nut 906 (right-hand thread).
 2. Remove and dispose of O-ring 412.03.
 3. Remove impeller 230 with a puller.
 4. Place impeller 230 on a clean and level surface.
 5. Remove keys 940.01 from shaft 210.

Bearing brackets P08sx, P10ax, P12sx

- ✓ The notes and steps stated in (⇒ Section 7.4.1 Page 50) to (⇒ Section 7.4.4 Page 52) have been observed/carried out.
 - ✓ The back pull-out unit is kept in a clean and level assembly area.
1. Unbolt impeller hub cap 260.01.
 2. Remove and dispose of O-ring 412.03.

3. Bend open lockwasher 931.02.
4. Undo hexagon head bolt 901.87.
5. Remove the lockwasher and disc 550.87.
6. Remove impeller 230 with a puller.
7. Place impeller 230 on a clean and level surface.
8. Remove keys 940.01 from shaft 210.

7.4.6 Dismantling the shaft seal

7.4.6.1 Dismantling the mechanical seal

KSB 4K mechanical seal:

- ✓ The notes and steps stated in (⇒ Section 7.4.1 Page 50) to (⇒ Section 7.4.5 Page 52) have been observed/carried out.
1. Clamp the bearing to the motor-side shaft end in vertical position.
 2. Pull off the shaft sleeve with the seat ring and O-ring, using an extractor in the removal groove in shaft protecting sleeve 524.01.
 3. Pull the seat ring out of the shaft sleeve.
 4. Undo hexagon head bolts 901.22. Then remove discharge cover 163 with joint ring 411.10 and spring-loaded ring with secondary seal and spring arrangement form the bearing bracket lantern.
 5. Push the spring-loaded ring with secondary seal out of the casing cover.
 6. Undo screws with springs and thrust ring.

7.4.6.2 Dismantling the packed gland

- ✓ The notes and steps stated in (⇒ Section 7.4.1 Page 50) to (⇒ Section 7.4.5 Page 52) have been observed/carried out.
 - ✓ The back pull-out unit is kept in a clean and level assembly area.
1. Undo hexagon nuts 920.02 at gland follower 452.01.
 2. Remove gland follower 452.01.
Watch discs 550.01.
 3. Undo hexagon head bolts 901.22. Then remove discharge cover 163 from bearing bracket lantern 344.
 4. Remove discharge cover 163 with gland packing and drip plate 463.01.
 5. Remove the gland packing from the packing chamber.
 6. Push out neck bush 456.01.

7.4.7 Dismantling the bearings

- ✓ The notes and steps stated in (⇒ Section 7.4.1 Page 50) to (⇒ Section 7.4.6 Page 53) have been observed/carried out.
1. Undo hexagon nuts 920.04 and remove bearing bracket lantern 344.
 2. Pull shaft protecting sleeve 524.01 with O-ring 412.06 off shaft 210.
 3. Bend open and pull off thrower 507.01
 4. Undo the socket head cap screw in the coupling hub.
 5. Pull the coupling hub off shaft 210 with a puller.
 6. Remove key 940.02.
 7. Undo socket head cap screws 914.01/914.02. Then remove bearing cover 360.01 with gasket 400.01 and shaft seal ring 421.01 at the pump end.

	NOTE
	<p>Bearing brackets P08sx/P10ax/P12sx only</p> <ul style="list-style-type: none"> ▷ Remove V-ring 411.77. ▷ Undo socket head cap screws 914.01. ▷ Remove bearing cover 360.01 with gasket 400.01, disc 507.11 and O-ring 412.36.

8. Use grub screws 904.01 (bearing brackets P08sx/P10ax/P12sx: forcing screws 901.91) to carefully drive shaft 210 with bearing carrier 382, angular contact ball bearing 320.02 and the inner ring of cylindrical roller bearing 322.01 out of bearing bracket 330 towards the drive end.
9. Place shaft 210 with angular contact ball bearing in a suitable location.
10. Remove support disc 550.23 and circlips 932.01/932.03.
11. For bearing brackets P08sx/P10ax/P12sx: Remove V-ring 411.78.
12. Remove the outer ring of cylindrical roller bearing 322.01 (roller cage) from bearing bracket 330.
13. Pull bearing carrier 382 with O-ring 412.02 and shaft seal ring 421.01 off angular contact ball bearing 320.02.
14. Bend open lockwasher 931.01.
15. Undo locknut 920.21 (right-hand thread!).
16. Remove lockwasher 931.01.
17. For bearing brackets P08sx/P10ax/P12sx: remove disc 507.12.
18. Heat up angular contact ball bearing 320.02 and the inner ring of cylindrical roller bearing 322.01 to 80 °C, and pull them off shaft 210.

7.4.8 Removing the wear plate

- ✓ The notes and steps stated in (⇒ Section 7.4.1 Page 50) to (⇒ Section 7.4.7 Page 53) have been observed/carried out.
1. Undo hexagon head bolts 901.03 or socket head cap screws 914.05.
 2. Remove joint rings 411.13.
 3. Remove wear plate 135.01 with O-rings 412.25/412.75.

7.5 Reassembling the pump set

7.5.1 General notes/Safety regulations

	CAUTION
	<p>Improper reassembly Damage to the pump!</p> <ul style="list-style-type: none"> ▷ Reassemble the pump (set) in accordance with the general rules of sound engineering practice. ▷ Use original spare parts only.

Sequence Always reassemble the pump in accordance with the corresponding general assembly drawing. (⇒ Section 9.1 Page 71)

Seal elements

▪ **Gaskets**

- Always use new gaskets, making sure that they have the same thickness as the old ones.
- Always fit gaskets of asbestos-free materials or graphite without using lubricants (e.g. copper grease, graphite paste).

▪ **O-rings**

- Never use O-rings that have been glued together from material sold by the metre.

	CAUTION
	<p>Contact of O-ring with graphite or similar material Fluid could escape!</p> <ul style="list-style-type: none"> ▷ Do not coat O-ring with graphite or similar material. ▷ Use animal fats or lubricants based on silicone or PTFE.

▪ **Assembly adhesives**

- For gaskets, avoid the use of assembly adhesives, if possible.
- Should assembly adhesives be required after all, use a commercially available contact adhesive (e.g. "Pattex").
- Only apply adhesive at selected points and in thin layers.
- Never use quick-setting adhesives (cyanoacrylate adhesives).
- Coat the locating surfaces of the individual components and screwed connections with graphite or similar before reassembly.

Tightening torques For reassembly, tighten all screws and bolts as specified in this manual. (⇒ Section 7.6 Page 64)

7.5.2 Fitting the wear plate

- ✓ The individual parts are kept in a clean and level assembly area.
 - ✓ All disassembled parts have been cleaned and checked for wear.
 - ✓ Any damaged or worn parts have been replaced by original spare parts.
 - ✓ The sealing surfaces have been cleaned.
1. Fit O-rings 412.25/412.75 on wear plate 135.01.
 2. Place wear plate 135.01 into the pump casing.
 3. Screw wear plate 135.01 to the pump casing with hexagon head bolts 914.05 or socked head cap screws 914.05 and joint rings 411.13.
Tightening torque (⇒ Section 7.6.1 Page 64)

7.5.3 Fitting the bearings

- ✓ The individual parts are kept in a clean and level assembly area.
 - ✓ All disassembled parts have been cleaned and checked for wear.
 - ✓ Any damaged or worn parts have been replaced by original spare parts.
 - ✓ The sealing surfaces have been cleaned.
 - ✓ The notes and steps stated in (⇒ Section 7.5.1 Page 54) to (⇒ Section 7.5.2 Page 55) have been observed/carried out.
1. Heat up angular contact ball bearing 320.02 and the inner ring of cylindrical rolling element bearing 322.01 to approx. 80 °C in an oil bath.
 2. For bearing brackets P10ax/P12sx: fit bush 500.21 on the shaft.
 3. Push the angular contact ball bearing and the inner ring of cylindrical roller bearing 322.01 onto shaft 210 until they will not go any further.

	NOTE
	<p>Angular contact ball bearings must be installed in "O" arrangement. Angular contact ball bearings installed in pairs must always be from the same manufacturer.</p>

4. Use a spanner wrench to tighten keywayed nut 920.21 without lockwasher 931.01.
5. Let angular contact ball bearing 320.02 cool down to approximately 5 °C above ambient temperature.
6. Re-tighten keywayed nut 920.21, then unscrew it again.

7. Apply a few spots of a suitable lubricant (e.g. Molykote) to the contact faces of lockwasher 931.01 and locknut 920.21.
8. For bearing brackets P08sx/P10ax/P12sx: fit disc 507.12.
9. Fit lockwasher 931.01.
10. Tighten locknut 920.21.
11. Bend back lockwasher 931.01.
12. Pull bearing carrier 382 onto angular contact ball bearing 320.02.
13. Remove support disc 550.23.
14. Insert circlips 932.01/932.03 into the bearing bracket/bearing carrier.
15. Fit the outer ring of angular contact ball bearing 322.01.
16. Carefully push pre-assembled shaft 210 with bearing carrier 382, O-ring 412.02 and lip seal 421.02 into bearing bracket 330 from the drive end until it will not go any further.
Watch the position of the return bores for oil recirculation.
17. Tighten socket head cap screws 914.02 (for bearing brackets P08sx/P10ax/P12sx: hexagon head bolt 901.95).
Tightening torque (⇒ Section 7.6.1 Page 64)
18. Insert grub screws 902.04.
19. For bearing brackets P08sx/P10ax/P12sx: fit V-ring 411.78 and hexagon forcing screws 901.91.
Make sure the external surfaces of V-rings 411.77/78 are flush with the external surface of the bearing cover/bearing carrier.
20. Fit O-ring 412.36 and disc 507.11.
21. Fit pump-end bearing cover 360.01 with joint ring 400.01.
Take care not to damage lip seal 421.01.
For bearing brackets P08sx/P10ax/P12sx: fit V-ring 411.77 instead of lip seal.
22. Tighten socket head cap screws 914.01 at the pump end..
Tightening torque (⇒ Section 7.6.1 Page 64)
23. Fit bearing bracket lantern 344 with studs 902.04.
24. Tighten hexagon nuts 920.04 at the flange of bearing bracket 330.
25. Fit keys 940.02.
26. Pull the coupling hub onto the shaft end.
27. Secure the coupling hub with the set screw.
28. Fit thrower 507.01, if any.

7.5.4 Installing the shaft seal

7.5.4.1 Installing the mechanical seal

The following rules must be observed when installing the mechanical seal:

- For mounting the mechanical seal, proceed as shown in the seal installation drawing.
- Work cleanly and accurately.
- Only remove the protective wrapping of the contact faces immediately before assembly takes place.
- Prevent any damage to the sealing surfaces or O-rings.
- After inserting the seat ring, check that it is plane-parallel in relation to the casing part.
- Make sure that the surface of the shaft protecting sleeve is absolutely clean and smooth, and that the sleeve's mounting edge is chamfered.

- When sliding the rotating assembly onto the shaft protecting sleeve, take appropriate precautions to protect the shaft protecting sleeve's surface from damage.
- On pumps with double-acting mechanical seal, properly vent the mechanical seal chamber and apply the required pressure specified in the general arrangement drawing (also during standstill).
- Also ensure quench liquid supply during pump standstill.

Installing the mechanical seal - KWP 4K

- ✓ The assembled bearing and the individual parts of mechanical seal 433 are kept in a clean and level assembly area.
 - ✓ All disassembled parts have been cleaned and checked for wear.
 - ✓ Any damaged or worn parts have been replaced by original spare parts.
 - ✓ The sealing surfaces have been cleaned.
 - ✓ The notes and steps stated in (⇒ Section 7.5.1 Page 54) to (⇒ Section 7.5.3 Page 55) have been observed/carried out.
1. Insert thrust ring 474 into the turned recess on the rear side of the casing cover.
 2. Push springs 477 onto socket head cap screws 914.
 3. Apply a thread-locking compound to screws 914 (recommendation).
 4. Thread socket head cap screws 914 with fitted springs 477 through the holes in thrust ring 474 and fasten them inside the pump cover.
Important: Make sure that thrust ring 474 can move freely. Do not screw on the thrust ring.
Tightening torque (⇒ Section 7.6.1 Page 64)

	CAUTION
	<p>Contact of O-ring with lubricant made of mineral grease or oil Damage to the O-ring!</p> <ul style="list-style-type: none"> ▷ Make sure that O-rings made of ethylene propylene rubber cannot come into contact with mineral oil or mineral grease. ▷ Make sure that O-rings made of silicone rubber cannot come into contact with silicone oil or silicone grease.

5. Coat O-ring 412.02 and the groove in the casing cover with a suitable lubricant.
6. Insert O-ring 412.02 into the groove of the casing cover.
7. Carefully install spring-loaded ring 472.
Important: Make sure that thrust ring 474 can move freely.
8. Mount the complete discharge cover with joint ring 411.10 on bearing bracket lantern 344.
9. Tighten hexagon head bolts 901.22.
Tightening torque (⇒ Section 7.6.1 Page 64)
10. Insert O-ring 412.01 for seat ring 475 into shaft sleeve 523.

	CAUTION
	<p>Use of grease or other permanent lubricants Hinders torque transmission! Overheating of and damage to the pump!</p> <ul style="list-style-type: none"> ▷ If required, use soft soap to reduce friction. Never use grease or other permanent lubricants. ▷ Do not coat seal faces with grease or oil.

11. Carefully push in seat ring 475.
12. For bearing brackets P08sx/P10ax/P12sx (sizes 80, 100, 120):
fit two torque-transmitting pins into the seat location of shaft sleeve 523.
Make sure the two pins engage in the recesses provided in the seat ring.
13. Dry and clean the seal faces.

14. Slip shaft sleeve 523 with seat ring 475 onto the pump shaft until it abuts against the shaft shoulder.

7.5.4.2 Packing the gland

Gland packing chamber

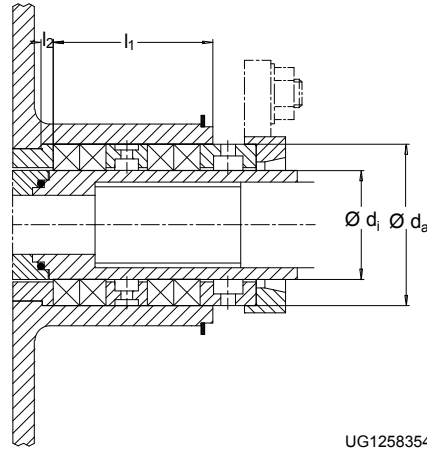

UG1258354

Fig. 20: Dimensions of the packing chamber / Number of packing rings

Table 21: Gland packing chamber

Bearing bracket	Gland packing chamber					Number of packing rings	
	$\varnothing d_i$	$\varnothing d_a$	□	l_1	l_2	with lantern ring	without lantern ring
P03ax	45	65	10	64	8	4 ¹⁸⁾	6
P04ax	55	75	10	64	8	4 ¹⁸⁾	6
P05ax	70	95	12.5	79	8	4 ¹⁸⁾	6
P06x	80	105	12.5	79	10	4 ¹⁸⁾	6
P08sx	100	132	16	103	10	4 ¹⁸⁾	6
P10ax	120	152	16	103	7	4 ¹⁸⁾	6
P12sx	140	172	16	103	7	4 ¹⁸⁾	6

¹⁸⁾ For model 4 (see illustration "Available models"): 1 spacer ring and 3 packing rings

Models

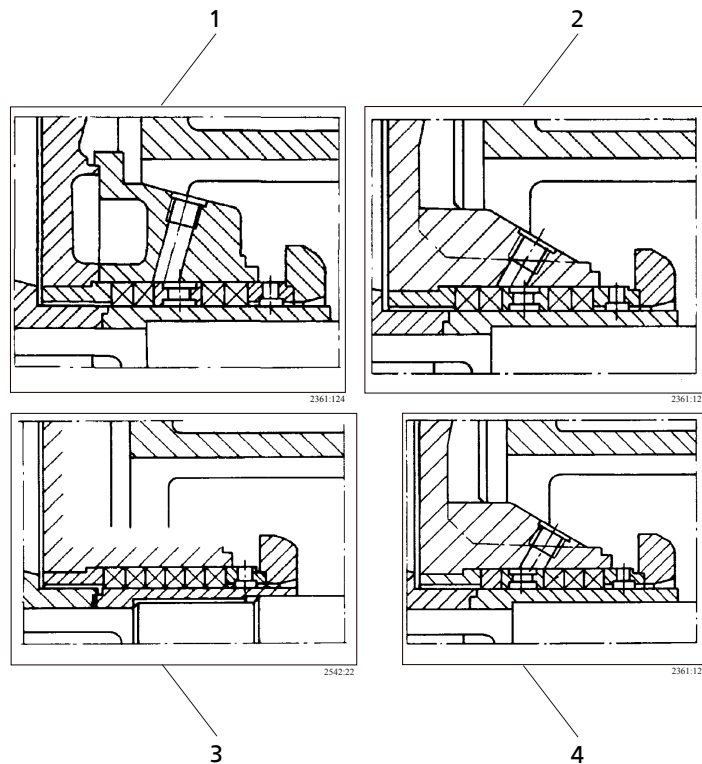

Fig. 21: Available models

1/2	Packing with barrier liquid connection (standard)	3	Packing without lantern ring
4	Packing with flushing liquid connection		

Procedure

For pure graphite packings see supplementary operating instructions. Always use pre-compressed packing rings.

- ✓ The assembled bearings as well as the individual parts are kept in a clean and level assembly area.
 - ✓ All disassembled parts have been cleaned and checked for wear.
 - ✓ Any damaged or worn parts have been replaced by original spare parts.
 - ✓ The sealing surfaces have been cleaned.
 - ✓ The notes and steps stated in (⇒ Section 7.5.1 Page 54) to (⇒ Section 7.5.3 Page 55) have been observed/carried out.
1. Screw stuffing box housing 451.01 (if any) to discharge cover 163. Tightening torque (⇒ Section 7.6.1 Page 64)
 2. Press neck bush 456.01 into the discharge cover.
 3. For packings with barrier liquid connection (see illustration "Available models", items 1 and 2) also fit lantern ring 458.01 in its specified location.
 4. Insert the first packing ring, ensuring that its cut edge is in horizontal position.
 5. Hold the packing ring in place and slide shaft protecting sleeve 524 (chamfered side first) into the gland packing chamber from the pump end.
 6. Slightly expand the inside diameter of the packing ring by moving the shaft protecting sleeve back and forth. Then pull out shaft protecting sleeve 524. Insert each subsequent packing ring separately with its cut edge offset by 90° in relation to the previous one. Repeat the expansion procedure. Insert lantern ring 458.01, if any, in its the specified location (see illustration "Available models"). After inserting the last packing ring, shaft protecting sleeve 524 remains in the packing chamber.

7. Insert stuffing box ring 454.01 so that the joint face is in vertical position to gland follower 452.01.
8. Fit gland follower 452.01 and lightly fasten it by hand with the two hexagon nuts 920.02; watch discs 550.01.
9. Install completely packed discharge cover 163 with joint ring 411.10 and shaft protecting sleeve 524 in the pump and screw it to bearing bracket lantern 344.
10. Tighten hexagon head bolts 901.22.
Tightening torque (⇒ Section 7.6.1 Page 64)

7.5.5 Fitting the impeller

Bearing brackets P03ax, P04ax, P05ax, P06x

- ✓ The assembled bearings with shaft seal as well as the individual parts are kept in a clean and level assembly area.
 - ✓ All disassembled parts have been cleaned and checked for wear.
 - ✓ Any damaged or worn parts have been replaced by original spare parts.
 - ✓ The sealing surfaces have been cleaned.
 - ✓ Impeller bore, shaft and keyways are clean and free from burrs.
 - ✓ The notes and steps stated in (⇒ Section 7.5.1 Page 54) to (⇒ Section 7.5.4 Page 56) have been observed/carried out.
1. Insert keys 940.01 into the shaft keyway.
 2. Fit O-ring 412.06 on shaft sleeve 524.01.
 3. Mount the impeller with an impeller mounting and removal device.
 4. Insert O-ring 412.03.
 5. Fit and tighten impeller screw 906.
Tightening torque (⇒ Section 7.6.1 Page 64)
 6. Check the axial rotor alignment and re-align, if required.
Make sure the distance between the back vane/impeller 230 and discharge cover 163 is ≤ 1.5 mm.

Bearing brackets P08sx, P10ax, P12sx:

- ✓ The assembled bearing/mechanical seal as well as the individual parts are kept in a clean and level assembly area.
 - ✓ All disassembled parts have been cleaned and checked for wear.
 - ✓ Any damaged or worn parts have been replaced by original spare parts.
 - ✓ The sealing surfaces have been cleaned.
 - ✓ Impeller bore, shaft and keyways are clean and free from burrs.
 - ✓ The notes and steps stated in (⇒ Section 7.5.1 Page 54) to (⇒ Section 7.5.4 Page 56) have been observed/carried out.
1. Insert keys 940.01 into the shaft keyway.
 2. Fit O-ring 412.06 on shaft sleeve 524.01.
 3. Mount the impeller with an impeller mounting and removal device.
 4. Insert disc 550.87 and lockwasher 931.02.
 5. Tighten hexagon head bolt 901.87.
Tightening torque (⇒ Section 7.6.1 Page 64)
 6. Fit impeller hub cap 260 with O-ring 412.03.
 7. Check the axial shaft alignment. Re-adjust, if required.
Make sure the distance between the back vane/impeller 230 and discharge cover 163 is ≤ 1.5 mm.

7.5.6 Installing the back pull-out unit

- ✓ The notes and steps stated in (⇒ Section 7.5.1 Page 54) to (⇒ Section 7.5.5 Page 60) have been observed/carried out.
 - ✓ Any damaged or worn parts have been replaced by original spare parts.
 - ✓ The sealing surfaces have been cleaned.
1. Fit support foot 183.
 2. If required, prevent the back pull-out unit from tipping over (e.g. by suspending or supporting it).
 3. Push the back pull-out unit with new gasket 411.10 into pump casing 101. Make sure that the impeller does not abut the wear plate.
 4. Tighten nuts 920.01.
 5. Fasten support foot 183 to the baseplate with foundation bolts.

7.5.7 Adjusting the diagonal gap

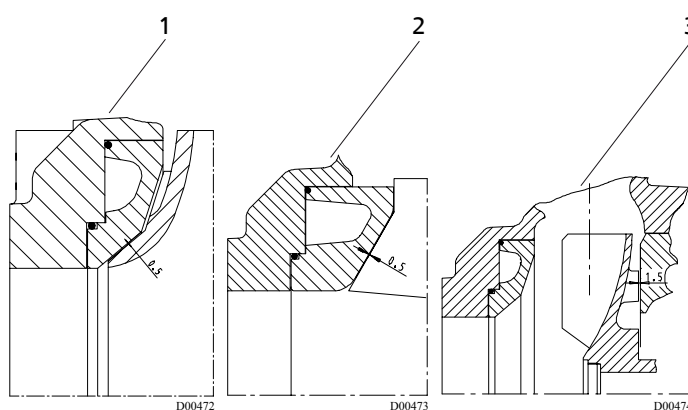

Fig. 22: KWP clearance gaps

1	Impeller type K	2	Impeller type O
3	Impeller type F		

Table 22: Clearance gaps between impeller and casing wear ring / between back vane and discharge cover

Impeller type	Nominal diameter of the discharge nozzle	Clearance gap
KWP K	< DN 300	0.50 mm + 0.1
	DN 300 to DN 450	0.60 mm + 0.1
KWP O	-	0.50 mm + 0.1
KWP F	-	1.50 mm + 0.1



NOTE

If the specified clearance gap is exceeded by more than 0.5 mm, adjust the diagonal gap as described below.

Closed impeller (KWP K) and open impeller (KWP O)

- ✓ The notes and steps stated in (⇒ Section 7.5.1 Page 54) to (⇒ Section 7.5.6 Page 61) have been observed/carried out.
1. Undo grub screws 904.01 or (for bearing brackets P10ax, P12sx) hexagon head bolts 901.91.
 2. Use socket head cap screws 914.02 to push the bearing carrier together with the rotor until it abuts wear plate 135.01.
 3. Measure the axial clearance between bearing bracket 330 and bearing carrier 382.

4. Undo socket head cap screws 914.02 or (for bearing brackets P10ax, P12sx) hexagon head bolts 901.95.
 5. Use grub screws 904.01 or (for bearing brackets P10ax, P12sx) hexagon head bolts 901.91 to pull the rotor back out towards the drive.
 6. Re-adjust the gap between impeller and wear plate as per the corresponding table and Fig. 22 "KWP clearance gaps".
 7. **Bearing brackets P03ax, P04ax, P05ax, P06x**
Fasten the rotor by tightening socket head cap screws 914.02. The grub screws ensure the clearance.
 - Bearing bracket P08sx**
Fasten the rotor by tightening hexagon head bolts 901.95. Grub screws 904.01 ensure the clearance.
Make sure the remaining gap between the bearing bracket and the bearing carrier is from from grease. Then close it with acrylate sealant.
 - Bearing brackets P10ax, P12sx**
Fasten the rotor by placing shims 89-4.12 on hexagon bolts 901.95.
Tighten hexagon head bolts 901.95.
Hexagon head bolts 901.91 ensure the clearance.
Make sure the remaining gap between the bearing bracket and the bearing carrier is from from grease. Then close it with acrylate sealant.
- Tightening torque** (⇒ Section 7.6.1 Page 64)

Free flow impeller (KWP F)

- ✓ The notes and steps stated in (⇒ Section 7.5.1 Page 54) to (⇒ Section 7.5.6 Page 61) have been observed/carried out.
1. Undo socket head cap screws 914.02.
 2. Screw in grub screws 904.01 to pull back the rotor until it will not go any further (impeller back vanes at discharge cover 163).
 3. Measure the axial clearance between bearing bracket 330 and bearing carrier 382.
 4. Undo grub screws 904.01 and use socket head cap screws 914.02 to push the rotor 1.5 mm towards the pump end.
 5. Fasten the rotor by tightening grub screws 904.01.
Tightening torque (⇒ Section 7.6.1 Page 64)

Remaining installation instructions (for all impeller types)

1. Fit forcing screws 901.30 on bearing bracket lantern 344 and forcing screws 901.31 on discharge cover 330.
2. For components which are not rotation-symmetrical, fit guard 680.11 (perforated plate) to bearing bracket lantern 344.
Threaded holes 12 x M6 x 10 are provided.

7.5.8 Mounting the motor

Model with coupling

	NOTE
	Steps 1 and 2 do not apply to versions with spacer-type coupling.

- ✓ The notes and steps stated in (⇒ Section 7.5.1 Page 54) to (⇒ Section 7.5.6 Page 61) have been observed/carried out.
1. Shift the motor to align it (⇒ Section 5.7 Page 32) and couple it to the pump.
 2. Fasten the motor to the baseplate.
 3. Connect the motor to the power supply (see documentation by the manufacturer).

Model with belt drive

	! WARNING
	<p>Motor tipping over Risk of squashing hands and feet!</p> <ul style="list-style-type: none"> ▷ Suspend or support the motor to prevent it from tipping over.

- ✓ The notes and steps stated in (⇒ Section 7.5.1 Page 54) to (⇒ Section 7.5.6 Page 61) have been observed/carried out.
- 1. Position motor bracket 81-54.01 on pump or baseplate.
- 2. Install motor bracket with threaded rods and hexagon nuts 920.23/920.24 on pump or baseplate.
- 3. Place the motor on the motor bracket and fasten it with hexagon bolts 901.62 and discs 550.6.
- 4. Connect the motor to the power supply (see documentation by the manufacturer).

7.5.9 Installing the belt drive

	CAUTION
	<p>Poorly checked and aligned motor connection Increased wear, insufficient power transmission, loud running noises!</p> <ul style="list-style-type: none"> ▷ Always use clean pulleys without any signs of wear. ▷ Align the shaft end of pump/motor flush with the pulleys. ▷ For multiple V-belt drives: <ul style="list-style-type: none"> - If replacing V-belts always replace the entire set of V-belts. - Use V-belts of the same length. ▷ Only pull on V-belts if this is possible without using any force. ▷ Only pull on V-belts by hand. Do not use any tools (e.g. levers). ▷ Tension the V-belts properly. (⇒ Section 5.6.2 Page 31).

	CAUTION
	<p>Swelling of V-belts due to aggressive ambient conditions Reduced service life of V-belts!</p> <ul style="list-style-type: none"> ▷ Protect V-belts suitably from oil mist, dripping oil and other chemical influences.

- ✓ The notes and steps stated in (⇒ Section 7.5.1 Page 54) to (⇒ Section 7.5.8 Page 62) have been observed/carried out.
- 1. Use bushing 540.02 to fit pulley 882.01 on pump shaft 210.
- 2. Use bushing 540.03 to fit pulley 882.02 on the motor shaft.
- 3. Align pulleys 882.01/882.02 so that they are flush with each other. (⇒ Section 5.6.2 Page 31)
- 4. Move threaded rods 904.23/904.24 and hexagon nuts 920.63/64 to position motor bracket 81-54.01 in such a way that the V-belts can be pulled onto pulleys 882.01/882.02 without any force.
- 5. Pull the V-belts onto pulleys 882.01/882.02.
The use of belt wax or similar substances is not necessary.
- 6. Tension the V-belts. (⇒ Section 5.6.2 Page 31) (⇒ Section 5.7.3 Page 34)

7.6 Tightening torques

7.6.1 Tightening torques of the pump

Casing bolts

	CAUTION
	<p>Use of an impact screw driver on Norihard casings (NH 153) Damage to screws and threads!</p> <ul style="list-style-type: none"> ▷ Do not use an impact screw driver. ▷ Make sure that the studs can be screwed in easily for the entire length of the thread.

Table 23: Tightening torques for screwed connections¹⁹⁾

Material	C35E+QT	A4-70
Stamp mark	YK/Y	A4-70/A4-70
Thread	Tightening torques [Nm]	
M12	40	55
M16	100	140
M20	190	200

Impeller screw

Table 24: Tightening torque of the impeller screw (part No. 906 and 901.87)¹⁹⁾

Bearing	Tightening torque M _A [Nm]
P03ax	50
P04ax	50
P05ax	120
P06x	180
P08sx/P10ax/P12sx	360

7.7 Spare parts stock

7.7.1 Ordering spare parts

Always quote the following data when ordering replacement or spare parts:

- Type series
- Material variant
- Size
- Seal code
- KSB order number
- Order item number
- Consecutive number
- Year of construction

Refer to the name plate for all data.

Also supply the following data:

- Description
- Part No.
- Quantity of spare parts

¹⁹⁾ Values refer to unlubricated screws. After repeated tightening of the threads and in case of good lubrication reduce the values by approx. 20 %.

- Delivery address
- Mode of dispatch (freight, mail, express freight, air freight)

Refer to the exploded view or general assembly drawing for part numbers and descriptions.

7.7.2 Recommended spare parts stock for 2 years' operation to DIN 24296

Table 25: Quantity of spare parts for recommended spare parts stock

Part No.	Description	Number of pumps (including stand-by pumps)						
		2	3	4	5	6 and 7	8 and 9	10 and more
135.01	Wear plate ²⁰⁾	2	2	2	3	3	4	50%
210	Shaft	1	1	1	2	2	2	20%
230	Impeller	1	1	1	2	2	2	20%
320.02	Angular contact ball bearing (set)	1	1	2	2	2	3	25%
322.01	Cylindrical roller bearing	1	1	2	2	2	3	25%
330	Bearing bracket, complete	-	-	-	-	-	1	2
Models with mechanical seal								
433.01	Mechanical seal, complete ²¹⁾	1	1	2	2	2	3	25%
	Spring-loaded ring ²¹⁾	2	3	4	5	6	7	90%
	Seat ring ²¹⁾	2	3	4	5	6	7	90%
	Secondary seal at seat ring ²¹⁾	2	3	4	5	7	9	100%
	Secondary seal at spring-loaded ring ²¹⁾	2	3	4	5	7	9	100%
	Spring (set) ²¹⁾	1	1	1	1	2	2	20%
Pump with gland packing								
456.01	Neck bush	1	1	2	2	2	3	30%
461.01	Gland packing (set)	4	4	6	6	6	8	100%
524.01	Shaft protecting sleeve	2	2	2	3	3	4	50%
---	Gaskets for pump casing (set)	4	6	8	8	9	12	150%

7.7.3 Interchangeability of pump components

Components featuring the same number in a column are interchangeable.

Table 26: Interchangeability of pump components

Pump size	Description																
	Pump casing	Suction wear plate	Discharge cover	Shaft	Impeller	Rolling element bearing	Bearing bracket	Bearing bracket lantern	Stuffing box housing	Gland follower	Stuffing box ring	Lantern ring	Gland packing	Casing wear ring	Thrower	Shaft protecting sleeve	Impeller screw
	Part No.																
	101	135.01	163	210	230	320/322	330	344	451.01	452.01	454.01	458.01	461	502.01	507	524.01	906
Bearing bracket P03ax																	
40-250	1	1	1	1	1	1	1	1	1	1	1	1	1	-	1	1	1
50-200	2	2	2	1	2	1	1	2	1	1	1	1	1	-	1	1	1
50-201	2	2	2	1	33	1	1	2	1	1	1	1	1	-	1	1	1

20) For KWP 250-315, 300-400 and 350-400: wear plate is replaced by casing wear ring

21) Optional

Pump size	Description																	
	Pump casing	Suction wear plate	Discharge cover	Shaft	Impeller	Rolling element bearing	Bearing bracket	Bearing bracket lantern	Stuffing box housing	Gland follower	Stuffing box ring	Lantern ring	Gland packing	Casing wear ring	Thrower	Shaft protecting sleeve	Impeller screw	
	Part No.																	
	101	135.01	163	210	230	320/322	330	344	451.01	452.01	454.01	458.01	461	502.01	507	524.01	906	
65-200	3	3	2	1	3	1	1	2	1	1	1	1	1	-	1	1	1	
65-201	3	3	2	1	34	1	1	2	1	1	1	1	1	-	1	1	1	
80-250	4	4	1	1	4	1	1	1	1	1	1	1	1	-	1	1	1	
80-251	4	4	1	1	35	1	1	1	1	1	1	1	1	-	1	1	1	
Bearing bracket P04ax																		
40-315	5	5	3	2	5	2	2	3	2	2	2	2	2	-	2	2	2	
50-400	6	6	4	2	6	2	2	4	2	2	2	2	2	-	2	2	2	
65-315	7	7	3	2	7	2	2	3	2	2	2	2	2	-	2	2	2	
65-313	7	30	3	2	36	2	2	3	2	2	2	2	2	-	2	2	2	
65-400	8	8	4	2	8	2	2	4	2	2	2	2	2	-	2	2	2	
80-315	9	9	3	2	9	2	2	3	2	2	2	2	2	-	2	2	2	
80-311	9	9	3	2	37	2	2	3	2	2	2	2	2	-	2	2	2	
100-250	10	10	5	2	10	2	2	1	2	2	2	2	2	-	2	2	2	
100-251	10	10	5	2	38	2	2	1	2	2	2	2	2	-	2	2	2	
100-253	10	31	5	2	39	2	2	1	2	2	2	2	2	-	2	2	2	
100-315	11	11	3	2	11	2	2	3	2	2	2	2	2	-	2	2	2	
Bearing bracket P05ax																		
80-400	12	12	6	3	12	3	3	5	3	3	3	3	3	-	3	3	3	
80-403	12	32	6	3	40	3	3	5	3	3	3	3	3	-	3	3	3	
100-400	13	13	6	3	13	3	3	5	3	3	3	3	3	-	3	3	3	
100-403	13	33	6	3	41	3	3	5	3	3	3	3	3	-	3	3	3	
150-315	16	16	7	3	16	3	3	6	3	3	3	3	3	-	3	3	3	
150-311	16	16	7	3	42	3	3	6	3	3	3	3	3	-	3	3	3	
150-400	17	17	6	3	17	3	3	5	3	3	3	3	3	-	3	3	3	
200-320	18	18	7	3	18	3	3	6	3	3	3	3	3	-	3	3	3	
Bearing bracket P06x																		
80-500	19	19	8	4	19	4	4	7	4	4	4	4	4	-	4	4	4	
125-500	20	20	9	4	20	4	4	7	4	4	4	4	4	-	4	4	4	
125-503	20	34	9	4	43	4	4	7	4	4	4	4	4	-	4	4	4	
200-400	21	21	10	4	21	4	4	5	4	4	4	4	4	-	4	4	4	
200-403	21	35	10	4	44	4	4	5	4	4	4	4	4	-	4	4	4	
250-315	22	-	11	4	22	4	4	6	4	4	4	4	4	33	4	4	4	
Bearing bracket P08sx																		
200-500	23	22	12	4	23	5	5	8	5	5	5	5	5	-	5	5	5	
200-501	33	36	12	4	45	5	5	8	5	5	5	5	5	-	5	5	5	
200-503	23	37	12	4	46	5	5	8	5	5	5	5	5	-	5	5	5	
250-400	24	23	13	4	24	5	5	9	5	5	5	5	5	-	5	5	5	
250-403	24	38	13	4	47	5	5	9	5	5	5	5	5	-	5	5	5	
250-500	25	24	12	4	25	5	5	8	5	5	5	5	5	-	5	5	5	
250-503	25	39	12	4	48	5	5	8	5	5	5	5	5	-	5	5	5	
250-505	25	40	12	4	49	5	5	8	5	5	5	5	5	-	5	5	5	
250-630	26	25	14	4	26	5	5	9	5	5	5	5	5	-	5	5	5	
250-634	26	41	14	4	50	5	5	9	5	5	5	5	5	-	5	5	5	

Pump size	Description																
	Pump casing	Suction wear plate	Discharge cover	Shaft	Impeller	Rolling element bearing	Bearing bracket	Bearing bracket lantern	Stuffing box housing	Gland follower	Stuffing box ring	Lantern ring	Gland packing	Casing wear ring	Thrower	Shaft protecting sleeve	Impeller screw
	Part No.																
	101	135.01	163	210	230	320/322	330	344	451.01	452.01	454.01	458.01	461	502.01	507	524.01	906
300-400	27	-	13	4	27	5	5	9	5	5	5	5	5	34	5	5	6
300-500	28	26	12	4	28	5	5	8	5	5	5	5	5	-	5	5	5
300-503	33	42	12	4	51	5	5	8	5	5	5	5	5	-	5	5	5
350-400	29	-	13	4	29	5	5	9	5	5	5	5	5	35	5	5	5
350-500	30	27	12	4	30	5	5	8	5	5	5	5	5	-	5	5	5
350-503	30	43	12	4	52	5	5	8	5	5	5	5	5	-	5	5	5
350-504	30	44	12	4	53	5	5	8	5	5	5	5	5	-	5	5	5
350-630	31	28	14	4	31	5	5	9	5	5	5	5	5	-	5	5	5
350-633	31	45	14	4	54	5	5	9	5	5	5	5	5	-	5	5	5
400-500	32	29	12	4	32	5	5	8	5	5	5	5	5	-	5	5	5
400-503	32	46	12	4	55	5	5	8	5	5	5	5	5	-	5	5	5
Bearing bracket 10ax																	
200-500	23	22	15	5	56	6	6	8	6	6	6	6	6	-	6	6	5
200-501	33	36	15	5	57	6	6	8	6	6	6	6	6	-	6	6	5
200-503	23	37	15	5	58	6	6	8	6	6	6	6	6	-	6	6	5
250-400	24	23	16	5	59	6	6	9	6	6	6	6	6	-	6	6	5
250-403	24	38	16	5	60	6	6	9	6	6	6	6	6	-	6	6	5
250-500	25	24	15	5	61	6	6	8	6	6	6	6	6	-	6	6	5
250-503	25	39	15	5	62	6	6	8	6	6	6	6	6	-	6	6	5
250-505	25	40	15	5	63	6	6	8	6	6	6	6	6	-	6	6	5
250-630	26	25	17	5	64	6	6	10	6	6	6	6	6	-	6	6	5
250-634	26	41	17	5	65	6	6	10	6	6	6	6	6	-	6	6	5
300-400	27	-	16	5	66	6	6	9	6	6	6	6	6	34	6	6	6
300-500	28	26	15	5	67	6	6	8	6	6	6	6	6	-	6	6	5
300-503	33	42	15	5	68	6	6	8	6	6	6	6	6	-	6	6	5
350-400	29	-	16	5	69	6	6	9	6	6	6	6	6	35	6	6	7
350-500	30	27	15	5	70	6	6	8	6	6	6	6	6	-	6	6	5
350-503	30	43	15	5	71	6	6	8	6	6	6	6	6	-	6	6	5
350-504	30	44	15	5	72	6	6	8	6	6	6	6	6	-	6	6	5
350-630	31	28	17	5	73	6	6	10	6	6	6	6	6	-	6	6	5
350-633	31	45	17	5	74	6	6	10	6	6	6	6	6	-	6	6	5
400-500	32	29	15	5	756	6	8	6	6	6	6	6	-	6	6	5	-
400-503	32	46	15	5	76	6	6	8	6	6	6	6	6	-	6	6	5
400-533	34	47	20	5	77	6	6	11	6	6	6	6	6	-	6	6	5
400-583	35	48	21	5	78	6	6	10	6	6	6	6	6	-	6	6	5
400-710	36	49	22	5	79	6	6	10	6	6	6	6	6	-	6	6	5
400-713	36	50	22	5	80	6	6	10	6	6	6	6	6	-	6	6	5
500-544	37	51	23	5	81	6	6	10	6	6	6	6	6	-	6	6	5
500-630	38	52	17	5	82	6	6	10	6	6	6	6	6	-	6	6	5
500-633	38	53	17	5	83	6	6	10	6	6	6	6	6	-	6	6	5
500-634	38	54	17	5	84	6	6	10	6	6	6	6	6	-	6	6	5
500-635	38	55	17	5	85	6	6	10	6	6	6	6	6	-	6	6	5
500-637	38	56	17	5	86	6	6	10	6	6	6	6	6	-	6	6	5

Pump size	Description																
	Pump casing	Suction wear plate	Discharge cover	Shaft	Impeller	Rolling element bearing	Bearing bracket	Bearing bracket lantern	Stuffing box housing	Gland follower	Stuffing box ring	Lantern ring	Gland packing	Casing wear ring	Thrower	Shaft protecting sleeve	Impeller screw
	Part No.																
	101	135.01	163	210	230	320/322	330	344	451.01	452.01	454.01	458.01	461	502.01	507	524.01	906
Bearing bracket 12sx																	
200-500	23	22	18	6	87	7	7	8	7	7	7	7	7	-	7	7	5
200-501	33	36	18	6	88	7	7	8	7	7	7	7	7	-	7	7	5
200-503	23	37	18	6	89	7	7	8	7	7	7	7	7	-	7	7	5
250-500	25	24	18	6	90	7	7	8	7	7	7	7	7	-	7	7	5
250-505	25	39	18	6	91	7	7	8	7	7	7	7	7	-	7	7	5
250-503	25	40	18	6	92	7	7	8	7	7	7	7	7	-	7	7	5
250-630	26	25	19	6	93	7	7	10	7	7	7	7	7	-	7	7	5
250-634	26	41	19	6	94	7	7	10	7	7	7	7	7	-	7	7	5
300-500	28	26	18	6	95	7	7	8	7	7	7	7	7	-	7	7	5
300-503	33	42	18	6	96	7	7	8	7	7	7	7	7	-	7	7	5
350-500	30	27	18	6	97	7	7	8	7	7	7	7	7	-	7	7	5
350-503	30	43	18	6	98	7	7	8	7	7	7	7	7	-	7	7	5
350-504	30	44	18	6	99	7	7	8	7	7	7	7	7	-	7	7	5
350-630	31	28	19	6	100	7	7	10	7	7	7	7	7	-	7	7	5
350-633	31	45	19	6	101	7	7	10	7	7	7	7	7	-	7	7	5
400-500	32	29	18	6	102	7	7	8	7	7	7	7	7	-	7	7	5
400-503	-	46	18	6	103	7	7	8	7	7	7	7	7	-	7	7	5
400-533	34	47	24	6	104	7	7	11	7	7	7	7	7	-	7	7	5
400-583	35	48	25	6	105	7	7	10	7	7	7	7	7	-	7	7	5
400-710	36	49	26	6	106	7	7	10	7	7	7	7	7	-	7	7	5
400-713	36	50	26	6	107	7	7	10	7	7	7	7	7	-	7	7	5
500-544	37	51	27	6	108	7	7	10	7	7	7	7	7	-	7	7	5
500-630	38	52	19	6	109	7	7	10	7	7	7	7	7	-	7	7	5
500-633	38	53	19	6	110	7	7	10	7	7	7	7	7	-	7	7	5
500-634	38	54	19	6	111	7	7	10	7	7	7	7	7	-	7	7	5
500-635	38	55	19	6	112	7	7	10	7	7	7	7	7	-	7	7	5
500-637	38	56	19	6	113	7	7	10	7	7	7	7	7	-	7	7	5

8 Trouble-shooting

- A Pump delivers insufficient flow rate
- B Motor overload
- C Excessive pump discharge pressure
- D Excessive bearing temperature
- E Leakage at the pump
- F Excessive leakage at the shaft seal
- G Vibrations during pump operation
- H Excessive rise of temperature inside the pump

Table 27: Trouble-shooting

A	B	C	D	E	F	G	H	Possible cause	Remedy ²²⁾
X								Pump delivers against an excessively high discharge pressure.	Re-adjust to duty point.
x								Excessively high back pressure.	Check plant for impurities. Fit a larger impeller. ²³⁾ Increase the speed (turbine, I.C. engine).
X						X	X	Pump or piping are not completely vented or primed.	Vent and/or prime.
X								Supply line or impeller clogged.	Remove deposits in the pump and/or piping.
X								Formation of air pockets in the piping.	Modify the piping. Fit a vent valve.
			X		X	X		Pump is warped or sympathetic vibrations in the piping.	Check pipeline connections and secure fixing of pump; if required, reduce the distances between the pipe clamps. Fix the pipelines using anti-vibration material.
X						X	X	Suction head is too high, NPSH _{available} (positive suction head) is too low.	Check/alter liquid level. Fully open the shut-off valve in the suction line. Change suction line if the friction losses in the suction line are too high. Check any strainers installed/suction opening. Observe permissible speed of pressure fall.
			X					Increased axial thrust. ²³⁾	Correct rotor adjustment.
X								Air intake at the shaft seal.	Fit new shaft seal.
X								Wrong direction of rotation.	Interchange two of the phases of the power supply cable.
X	X							Motor is running on two phases only.	Replace the defective fuse. Check the electric cable connections.
X								Speed is too low. - Pump operation with frequency inverter - Pump operation without frequency inverter	- Increase voltage/frequency at the frequency inverter in the permissible range. - Check the voltage.
						X		Defective bearing(s)	Fit new bearing(s).
			X			X	X	Flow rate is too low.	Increase the minimum flow rate.
X						X		Wear of internal pump parts	Replace worn components by new ones.
	X							Density or viscosity of the fluid pumped is higher than stated in the purchase order.	Contact KSB.
					X			Use of unsuitable materials.	Change the material combination.
	X	X						Speed is too high.	Reduce speed. ²³⁾

²²⁾ Pump pressure must be released before attempting to remedy faults on parts which are subjected to pressure.

²³⁾ Contact KSB.

A	B	C	D	E	F	G	H	Possible cause	Remedy ²²⁾
				X				Tie bolts/gasket defective.	Fit new seal between volute casing and discharge cover. Re-tighten the bolts.
					X			Worn shaft seal.	Fit new shaft seal.
X					X			Score marks or roughness on shaft protecting sleeve / shaft sleeve	Replace shaft protecting sleeve / shaft sleeve. Fit new shaft seal. Check the balancing line. Check throttling bush / throttle sleeve clearances.
					X			Lack of cooling liquid or dirty cooling chamber.	Increase cooling liquid quantity. Clean out cooling chamber. Purify/clean cooling liquid.
	X				X			Gland follower too tight or askew.	Correct.
	X					X		Pump back pressure is lower than specified in the purchase order.	Adjust duty point accurately.
					X			Vibrations during pump operation	Correct suction conditions. Re-align the pump set. Re-balance the impeller. Increase pressure at the pump suction nozzle.
			X		X	X		The pump set is misaligned.	Re-align the pump set.
			X					Insufficient or excessive quantity of lubricant or unsuitable lubricant.	Top up, reduce or change lubricant.
			X					Non-compliance with specified coupling distance.	Correct distance according to the general arrangement drawing.
	X							Operating voltage is too low.	Increase voltage. Check voltage drop in the power supply cable.
						X		Rotor is out of balance.	Clean impeller. Re-balance impeller.

²²⁾ Pump pressure must be released before attempting to remedy faults on parts which are subjected to pressure.

9 Related Documents

9.1 General assembly drawing with list of components

9.1.1 Bearing brackets P03ax to P06x

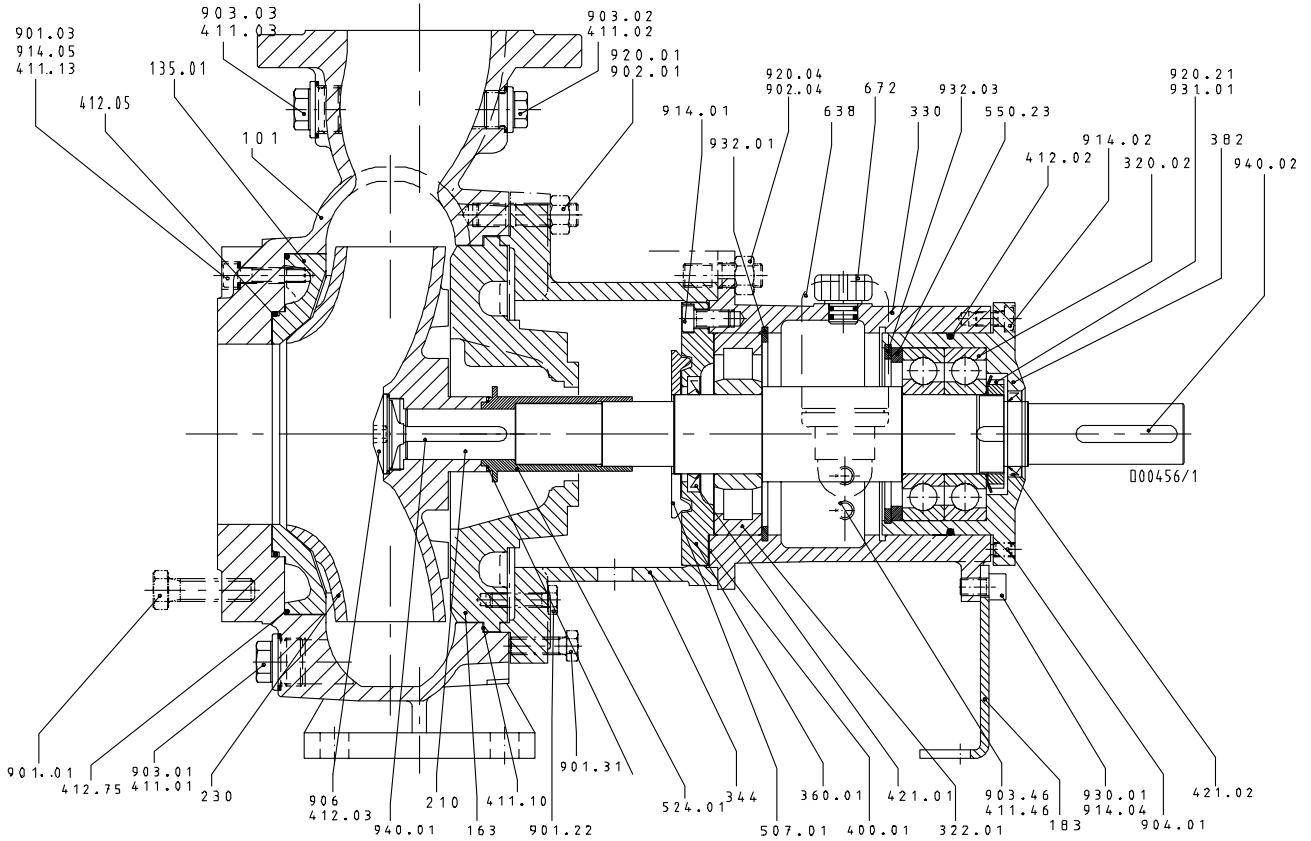
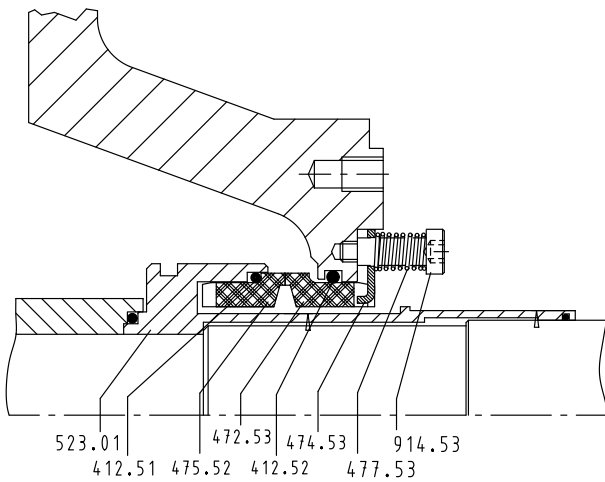

Fig. 23: Bearing brackets P03ax to P06x

a)



b)

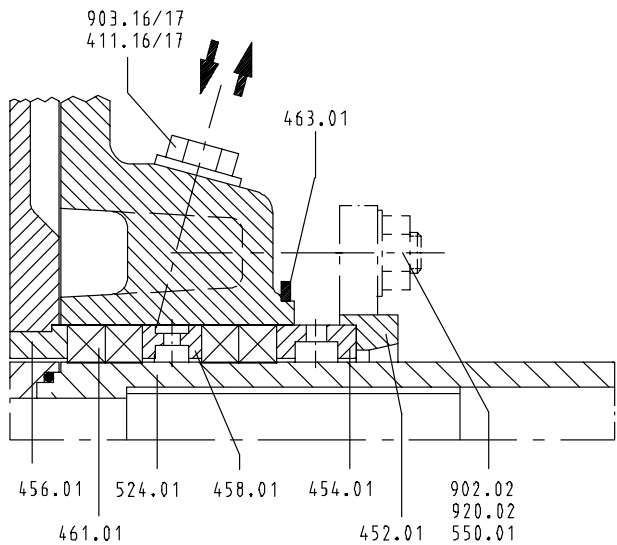

Fig. 24: a) 4K mechanical seal ; b) coolable gland packing

D00397

Part No.	Description	Scope of supply
101	Pump casing	with joint ring 411.01 ²⁴⁾ /.02 ²⁴⁾ /.031 ²⁴⁾ /.10, hexagon head bolt 901.01, stud 902.01, screwed plug 903.01 ²⁴⁾ /.02 ²⁴⁾ /.03 ²⁴⁾ , hexagon nut 920.01
135.01 ²⁵⁾	Wear plate	with joint ring 411.13, O-ring 412.05/.75, hexagon head bolt 901.03, socket head cap screw 914.05
163 ²⁶⁾	Discharge cover (A-type cover)	
163	Discharge cover (with bolted on stuffing box housing)	with gasket 400.05, joint ring 411.26, hexagon head bolt 901.22
183	Support foot	with socket head cap screw 914.04, spring washer 930.01
210	Shaft	with keywayed nut 920.21, lockwasher 931.01, key 940.01/.02
230	Impeller	with gasket 400.04
320.02	Angular contact ball bearing	
322.01	Cylindrical roller bearing	
330	Bearing bracket	
330	Bearing bracket, complete	with bearing cover 360.01, bearing carrier 382, gasket 400.01, joint ring 411.46, O-ring 412.02, lip seal 421.01/.02, support disc 550.23, constant level oiler 638, vent plug 672, screwed plug 903.46, socket head cap screw 914.01/.02, circlip 932.01/.03
344	Bearing bracket lantern	with forcing screw 901.31, stud 902.04, hexagon nut 920.04
360.01	Bearing cover	with gasket 400.01, socket head cap screw 914.01
382	Bearing carrier	with O-ring 412.02, grub screw 904.01, socket head cap screw 914.02, circlip 932.03
421.01/.02	Lip seal	
433.02	4K mechanical seal	with O-Ring 512.51/52, spring-loaded ring 472.53, thrust ring 474.53, seat ring 475.52, spring 477.53, socket head cap screw 914.53, shaft sleeve 523.01
451.01 ²⁴⁾	Stuffing box housing	with gasket 400.05, joint ring 411.16/.17/.18/.19/.26, drip plate 463.01, disc 550.01, stud 902.02, screwed plug 903.16/.17/.18/.19, hexagon nut 920.02
452.01 ²⁴⁾	Gland follower	
454.01 ²⁴⁾	Stuffing box ring, split	
456.01 ²⁴⁾	Neck bush	
458.01 ²⁴⁾	Lantern ring, split	
461.01 ²⁴⁾	Packing ring	
507.01	Thrower	
524.01	Shaft protecting sleeve	with O-ring 412.06
906	Impeller screw	with O-ring 412.03
99-9	Set of sealing elements	with gasket 400.01/.02/.03/.04, joint ring 411.01/.02/.03/.10/.13/.46, O-ring 412.02/.03/.05/.06/.75

²⁴⁾ If any

²⁵⁾ For 250-315, the wear plate is replaced by casing wear ring 502.01.

²⁶⁾ Models with mechanical seal

9.1.2 Bearing brackets P08sx to P12sx

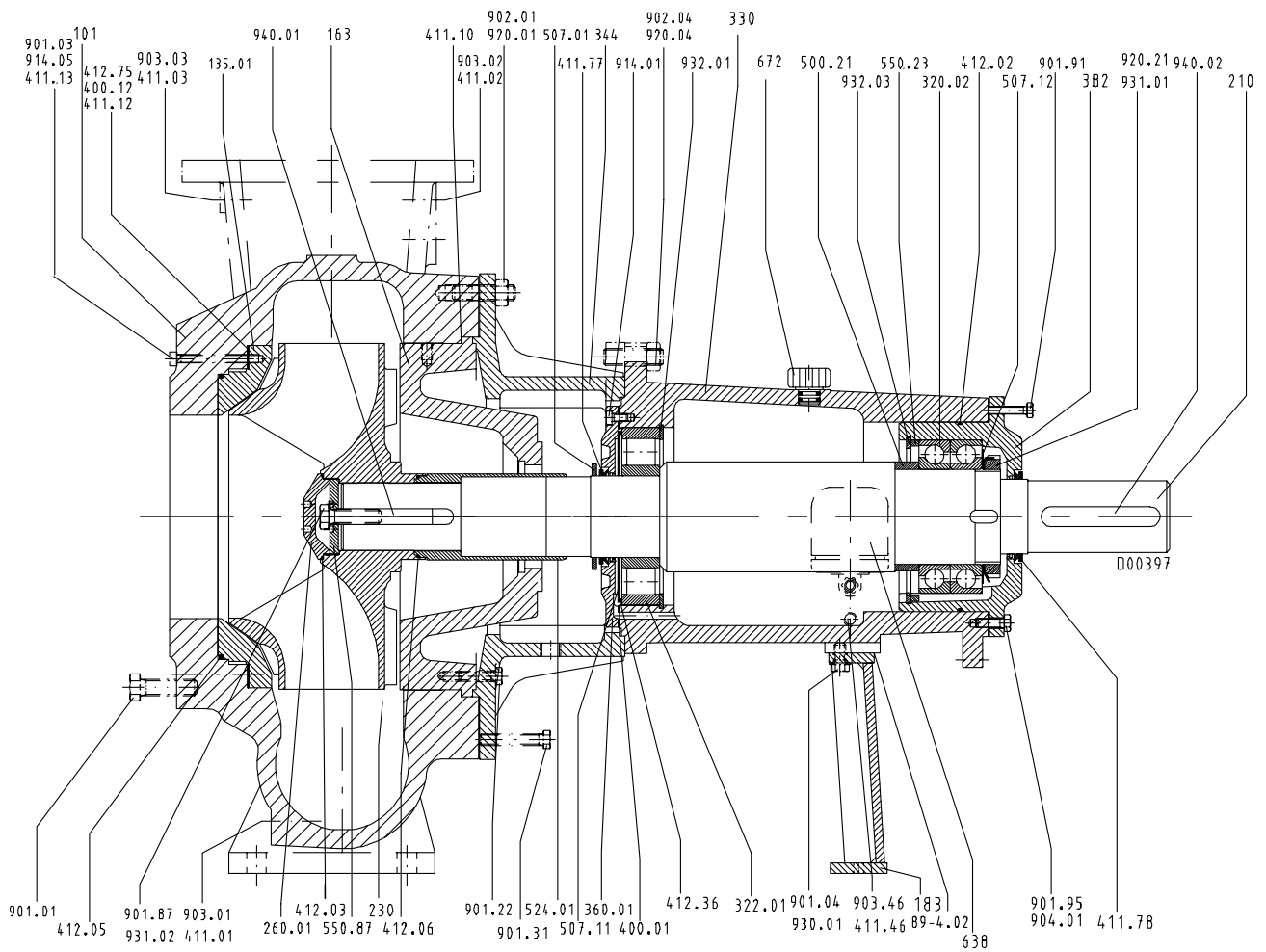
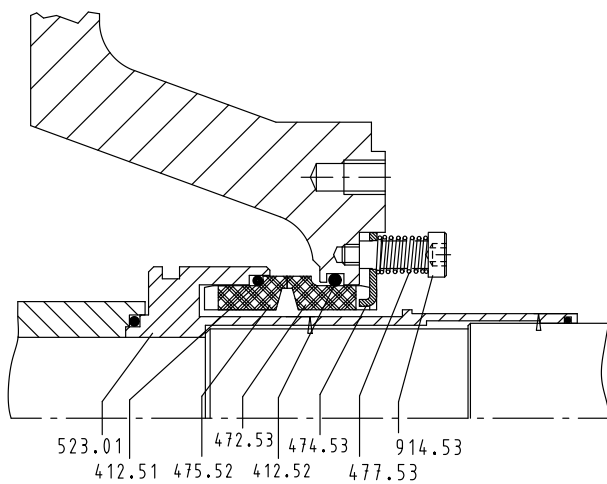
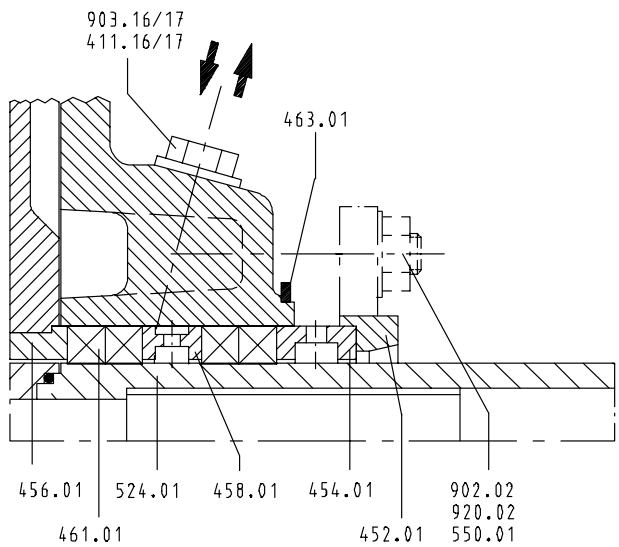

Fig. 25: Bearing brackets P08sx to P12sx

a)



b)



D00397

Fig. 26: a) 4K mechanical seal ; b) coolable gland packing

Part No.	Description	Scope of supply
101	Pump casing	with joint ring 411.01 ²⁷⁾ /.02 ²⁷⁾ /.03 ²⁷⁾ /.10, hexagon head bolt 901.01, stud 902.01, screwed plug 903.01 ²⁷⁾ /.02 ²⁷⁾ /.03 ²⁷⁾ , hexagon nut 920.01
135.01 ²⁸⁾	Wear plate	with joint ring 411.12/.13, O-ring 412.05/.75, hexagon head bolt 901.03, socket head cap screw 914.05
163 ²⁹⁾	Discharge cover (A-type cover)	
163	Discharge cover (with integrally cast stuffing box housing)	with joint ring 411.16/.17, drip plate 463.01, disc 550.01, stud 902.02, screwed plug 903.16/.17, hexagon nut 920.02
163	Discharge cover (with bolted on stuffing box housing)	with gasket 400.05, joint ring 411.26, hexagon head bolt 901.22
183	Support foot	with hexagon head bolt 901.04, spring washer 930.01, shims 89-4.02
210	Shaft	with keywayed nut 920.21, lockwasher 931.01, key 940.01/.02, ring 500.21
230	Impeller	with O-ring 412.06
320.02	Angular contact ball bearing	
322.01	Cylindrical roller bearing	
330	Bearing bracket	
330	Bearing bracket, complete	with bearing cover 360.01, gasket 400.01, joint ring 411.46, V-ring 411.77/.78, support disc 550.23, constant level oiler 638, vent plug 672, hexagon head bolt 901.91/.95, screwed plug 903.46, socket head cap screw 914.01, circlip 932.01/.03
344	Bearing bracket lantern	with forcing screw 901.31, stud 902.04, hexagon nut 920.04, hexagon head bolt 901.22
360.01	Bearing cover	with gasket 400.01, socket head cap screw 914.01, thrower 507.11, O-Ring 412.06
382	Bearing carrier	with O-ring 412.02, shims 89-4.12
411.77/.78	V-ring	
433.02	4K mechanical seal	with O-Ring 512.51/52, spring-loaded ring 472.53, thrust ring 474.53, seat ring 475.52, spring 477.53, socket head cap screw 914.53, shaft sleeve 523.01
451.01 ²⁷⁾	Stuffing box housing ³⁰⁾	with gasket 400.05, joint ring 411.16/.17/.18/.19/.26, drip plate 463.01, disc 550.01, stud 902.02, screwed plug 903.16/.17/.18/.19, hexagon nut 920.02
452.01 ²⁷⁾	Gland follower	
454.01 ²⁷⁾	Stuffing box ring, split	
456.01 ²⁷⁾	Neck bush	
458.01 ²⁷⁾	Lantern ring, split	
461.01 ²⁷⁾	Packing ring	
507.01/.11/.12	Thrower	
524.01	Shaft protecting sleeve	with O-ring 412.06
99-9	Set of sealing elements	with gasket 400.01, joint ring 411.01/.02/.03/.12/.13/.46, O-ring 412.02/.03/.05/.06

²⁷⁾ If any

²⁸⁾ For 300-400 and 350-400 wear plate replaced by casing wear ring 502.01.

²⁹⁾ Models with mechanical seal

³⁰⁾ For models with bolted on stuffing box housing

10 EC Declaration of Conformity

Manufacturer: **KSB Aktiengesellschaft**
Johann-Klein-Straße 9
67227 Frankenthal (Germany)

The manufacturer herewith declares that the **pump/pump set**:

KWP, KWPR, KWP-Bloc

KSB order number:

- is in conformity with the provisions of the following directives as applicable in their current version:
 - EC Machinery Directive 2006/42/EC

The manufacturer also declares that

- the following harmonised international standards were applied:
 - ISO 12100-1/A1, ISO 12100-2/A1,
 - ISO 14121-1,
 - EN 809/A1

Pegnitz, 29.12.2009

.....

Name

Function

Responsible for compiling the technical documentation
KSB Aktiengesellschaft
Bahnhofplatz 1
91257 Pegnitz (Germany)

11 Certificate of Decontamination

Type

Order number/

Order item number³¹⁾

Delivery date

Field of application:

Fluid handled³¹⁾:

Please tick where applicable³¹⁾:



radioactive



explosive



corrosive



toxic



harmful



bio-hazardous



highly flammable



safe

Reason for return³¹⁾:

Comments:

.....

The pump/accessories have been carefully drained, cleaned and decontaminated inside and outside prior to dispatch/placing at your disposal.

On sealless pumps, the rotor has been removed from the pump for cleaning.

- No special safety precautions are required for further handling.
- The following safety precautions are required for flushing fluids, fluid residues and disposal:

.....

.....

We confirm that the above data and information are correct and complete and that dispatch is effected in accordance with the relevant legal provisions.

.....
Place, date and signature

.....
Address

.....
Company stamp

³¹⁾ Required fields

Index

A

Abrasive fluids 44

B

Bearing temperature 47
Bearings 18

C

Certificate of decontamination 76
Clearance gaps 61
Commissioning/start-up 38
Constant level oiler 38
Coupling 48
Coupling alignment 30

D

Design 17
Design and function 20
Designation 16
Direction of rotation 37
Dismantling 51
Disposal 15

E

Explosion protection 11, 19, 22, 29, 30, 31, 33, 34, 35, 36, 39, 40, 41, 43, 46, 47, 48

F

Filling and venting 39
Filter 24, 48
Final check 40
Flow rate 44
Frequency of starts 43

G

Gland packing 41

I

Impeller type 18
Installation
 Installation on foundation 22
 Installation without foundation 23
Installation at site 22
Intended use 8
Interchangeability of pump components 65

M

Maintenance/ repair 46
Mechanical seal 41
Misuse 9
Monitoring equipment 12

N

Name plate 17
Noise characteristics 21

O

Oil lubrication
 Intervals 48
 Oil quality 49
Operating limits 8, 43
Order number 6
Ordering spare parts 64
Other applicable documents 6

P

Partly completed machinery 6
Permissible forces and moments at the pump nozzles 25
Piping 24
Preservation 14, 45
Problems 69
Product description 16
Pump casing 17
Pure graphite packing 41

R

Reassembly 51
Return to supplier 14
Returning to service 45
Running noises 47

S

Safety 8
Safety awareness 10
Scope of supply 21
Shaft seal 18
Shutdown 45
Start-up 41
Storage 14, 45
Switch off 42

T

Temperature limits 11
Tightening torques 64
Transport 13

W

Water cooling 40



KSB Aktiengesellschaft

P.O. Box 1361 • 91253 Pegnitz • Bahnhofplatz 1, 91257 Pegnitz (Germany)

Tel. +49 9241 71-0 • Fax +49 9241 71-1793

www.ksb.com